

Innovations

en

2023

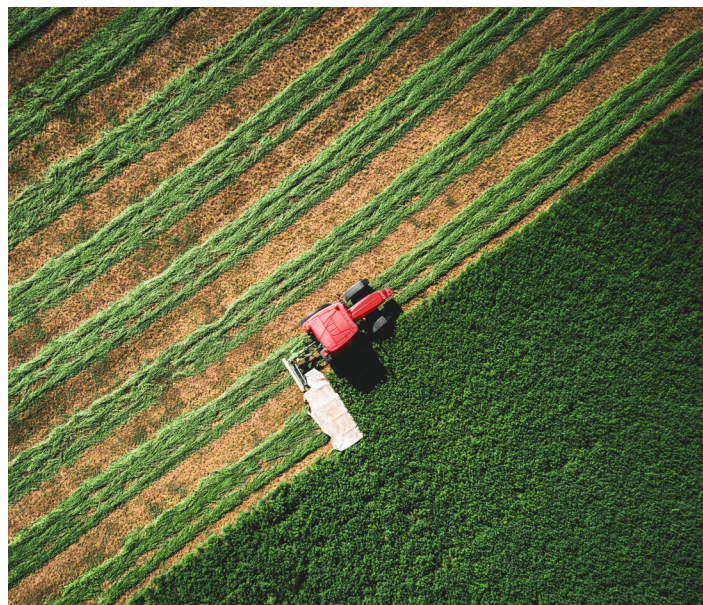
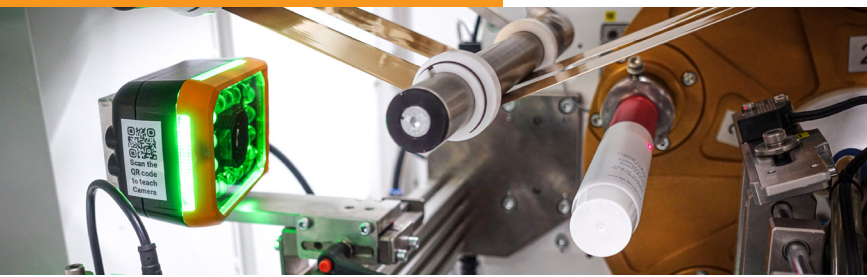

B&R is proud to present our latest innovations.

We're especially excited to put these innovations in the hands of our passionate people around the world. Wherever you are, there's a team of B&R experts who can't wait to co-create your next game-changing solution and bring your most ambitious visions to life.

Do more with less.

More productivity from less space, using less energy and creating less waste.

Open new opportunities.

Where teams and technologies converge, new possibilities emerge.

Build a better future.

Together, we transform industries and build a better future for the planet and everyone on it.



Happy reading,
Jörg Theis, CEO

004 –015	Openness
016 –023	Controls
024 –029	HMI
030 –035	Mobile Automation
036 –045	Motion
046 –059	Mechatronics
060 –063	Vision
064 –071	Scalable DCS



Freedom through open connectivity

mapp
TECHNOLOGY

B&R is widening its spectrum of supported protocols with the addition of an EtherCAT master. In addition to connecting the entire automation ecosystem with open-source POWERLINK and enabling seamless connectivity from the sensor to the cloud with OPC UA FX, B&R also offers a wide range of additional connectivity options for third-party devices. With the addition of EtherCAT to this mix, builders and operators of industrial machinery will now have even greater freedom to adapt their hardware to changing requirements.

01 The B&R automation ecosystem is open to the vast majority of today's fieldbus connectivity market.

The B&R automation ecosystem is already open to the majority of today's fieldbus market. In addition to license-free, open-source POWERLINK, it is possible to connect third-party devices via Profinet, Modbus, EtherNet/IP, DeviceNet, Profibus and CANopen. B&R continues to expand this offering by incorporating rising standards like IO-Link and the largest ecosystem for advanced interoperability, OPC UA. B&R is committed to helping its customers prepare for a rapidly approaching future where industrial networks are fully equipped for the IoT and advanced analytics. As a major driver in the

development of OPC UA and OPC UA FX, B&R and its partners are building a future of seamless IoT connectivity from the sensor to the cloud.

All options open

To ensure that its customers have every option open to connect the equipment they need today and tomorrow, B&R is expanding its portfolio of third-party I/O masters to include EtherCAT. As they safeguard their ability to deliver through future disruptions, machine builders gain a long-term competitive edge and offer their customers more operational resilience.

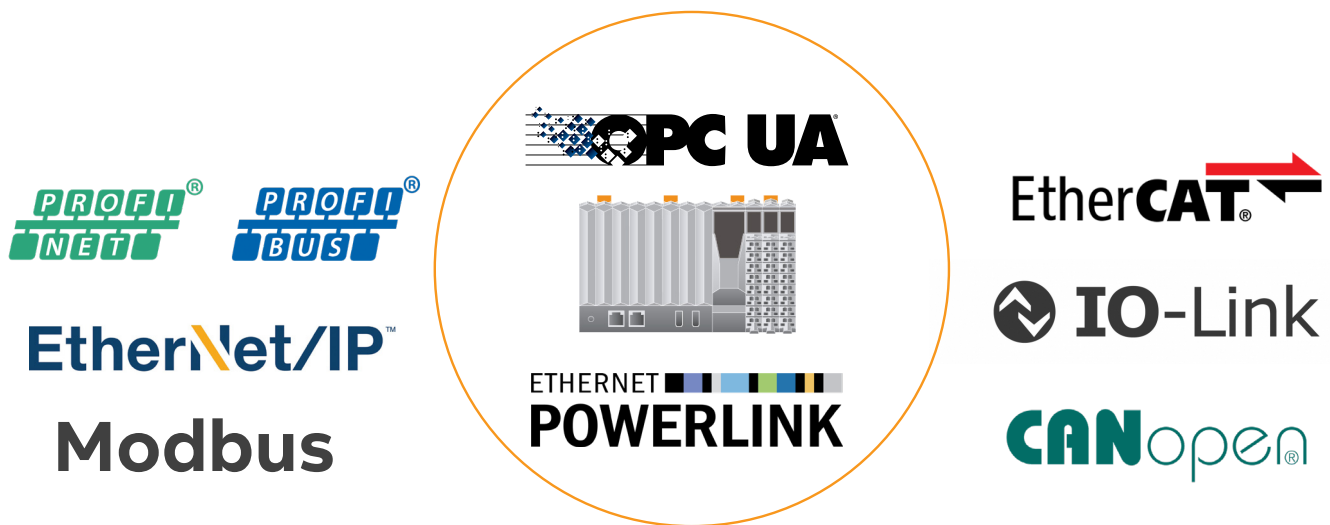

⊕ BENEFITS FOR MACHINE BUILDERS

- Investment security
- Long-term competitive edge
- Resilience against supply chain disruptions

⊕ BENEFITS FOR MANUFACTURERS

- Operational excellence
- Operational resilience
- Optimized TCO

Freedom through hardware-agnostic control



B&R is enhancing its runtime control system, Automation Runtime, with the ability to run on third-party hardware. Building on the seamless scalability of the B&R ecosystem, seamless migration between vendors now brings machine builders and operators unprecedented freedom. B&R solutions deliver industry-shaping performance together with operational resilience and long-term competitive edge.



Not only does B&R enable seamless scalability and interoperability within its own ecosystem, it is removing obstacles to migration between hardware vendors as well. The ability to operate Automation Runtime on third-party hardware is an important step on the road to full virtualization, and is made possible by the evolution of

virtual machine technology and an upgrade to the underlying real-time operating system (RTOS). With this enhancement, B&R customers will now have the freedom to switch between comparable control hardware quickly and with minimal compromise in performance, functionality and usability.





01

Automation Runtime is now able to run on 3rd-party PCs.

Operational resilience

B&R has long led the industry in hardware and software interoperability and open connectivity. Automation Runtime is built on an open architecture and provides seamless scalability across B&R's portfolio of PC, PLC and HMI systems.

It also offers customers a wide selection of CPU brands, classes and architectures with diverse sourcing options. Recent events have confirmed the importance of this approach, and this latest development will further strengthen B&R customers' resilience against supply chain disruptions.

⊕ BENEFITS FOR MACHINE BUILDERS

- Fully interchangeable control hardware
- Seamless migration
- Long-term competitive edge
- Resilience against supply chain disruptions

⊕ BENEFITS FOR MANUFACTURERS

- Operational resilience
- Investment security
- Optimized TCO

A new world of possibilities

The ability to leverage software from the IT world directly at the machine automation level opens up virtually endless possibilities to increase machine value and keep ahead of the competition. exOS technology from B&R erases long-standing boundaries to allow easy integration of Linux-based IT software in the automation environment.

exOS (pronounced "ex-sohs") acts as a bridge between B&R's real-time operating system Automation Runtime and any software developed in Linux – an enormous software ecosystem – using JavaScript, Python, HTML5, or any other high-level programming or markup language. It enables seamless integration of these languages with the IEC 61131-3 languages primarily used by machine application developers. The resulting automation solutions deliver production power together with state-of-the-art solutions that open up creative new business models.



⊕ BENEFITS FOR MACHINE BUILDERS

- Hybrid applications and advanced IT features
- Quick time to market and new business models
- Technology provider independence
- Open-source algorithms from global community

⊕ BENEFITS FOR MANUFACTURERS

- Advanced analytics and production optimization
- Fast integration of IT and operations
- Easy maintenance
- Minimal machine downtime

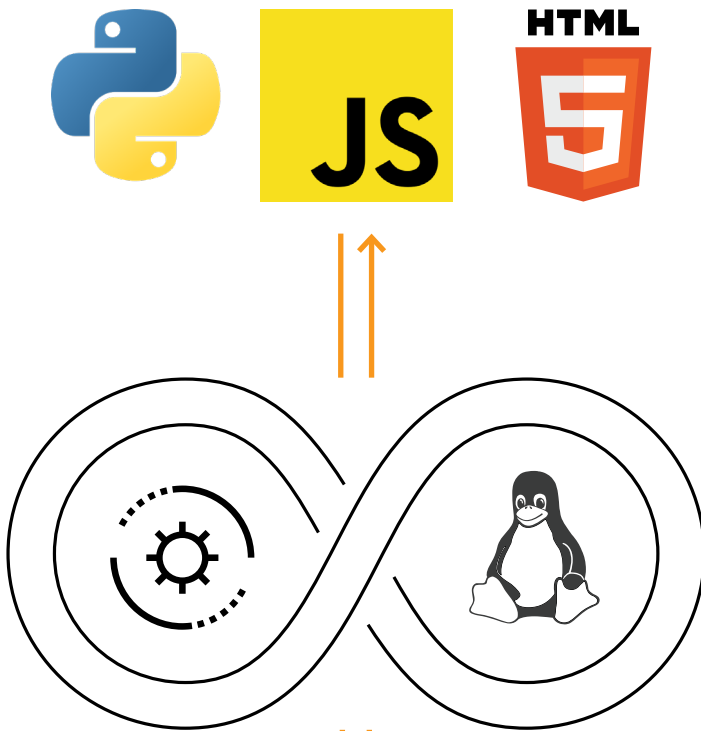

Easily incorporate the future

exOS makes it possible to set up robust Linux-based database systems directly on the machine that can be used to collect and store data for use in quality analytics. Advanced artificial intelligence and machine learning algorithms can be implemented to optimize the production processes themselves. For example, historical data could be used to improve a painting process. Another possibility would be to combine sophisticated path planning and collision avoidance systems already developed in Linux with the real-time motion control components supported by B&R Automation Runtime in an automated guided vehicle. Or how about cloud connectivity directly from the machine?

These are just a few examples; the only limit is the imagination. exOS provides a framework that lets machines speak virtually any language and accomplish nearly any task. Both the real-time operating system and Linux are logged for simple diagnostics, and end users benefit from minimal machine downtime with the ability to replace faulty hardware right out of the box. With exOS technology, the door to emerging technologies is open as never before.

mapp
SERVICES



Intuitive engineering, flexible collaboration

B&R's Automation Studio engineering environment features an intuitive new ladder logic editor and a more flexible approach to project management called Selective Versioning. Together, these new features help simplify complexity and accelerate time to market for new and updated machine software.



Intuitive visual programming

The new ladder diagram editor in Automation Studio provides unrivalled ease of use and opens up powerful automation tools for all users. The graphical interface offers a refreshed look and feel with colored function blocks, auto-connections and other enhancements.

When developers click on a location inside the editor, for example, a mini-toolbar pops up right next to the cursor, making it easy to find the coil or rung they are looking for. The intuitive user experience will help both developers and service technicians complete their work faster.

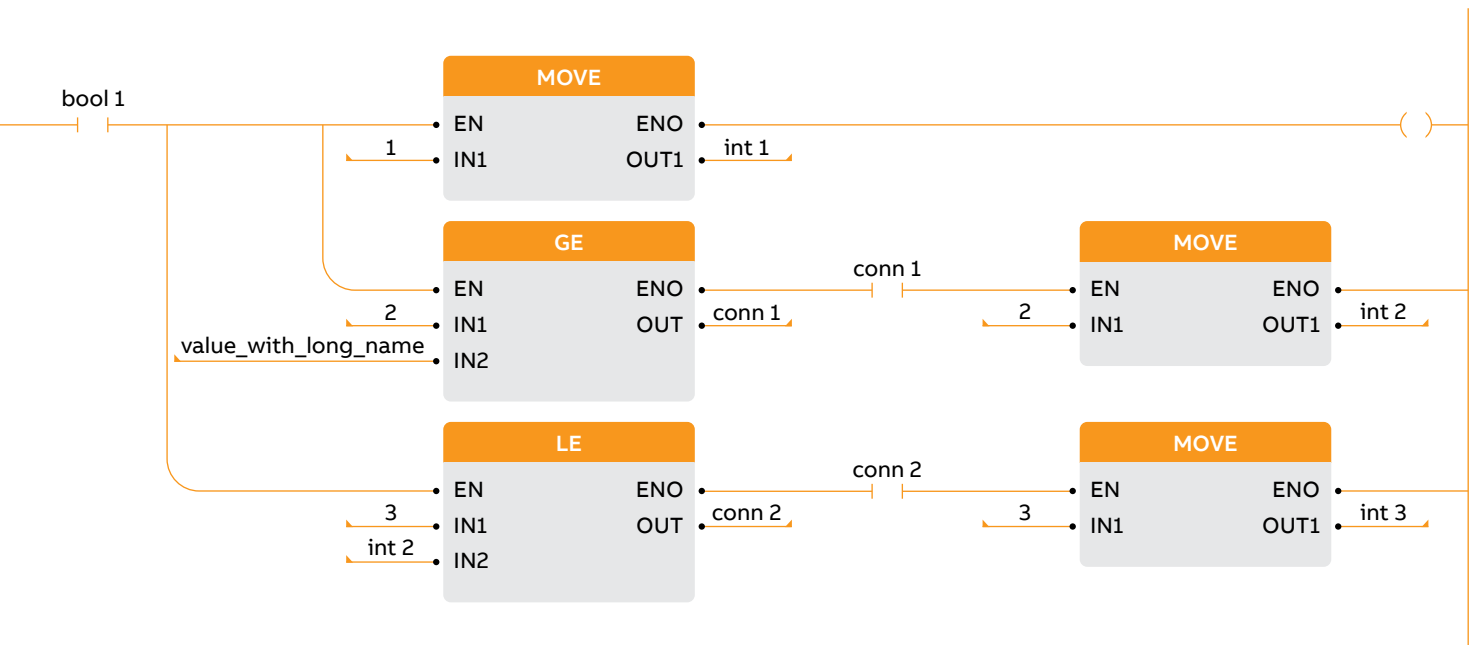

01 Intuitive new ladder diagram editor in Automation Studio.

02 Work seamlessly on projects without upgrading or converting.

Flexible project management

The latest iteration of Automation Studio also features Selective Versioning, which helps to reduce instances of incompatibility between software versions by decoupling projects from the Automation Studio environment itself. Engineers can now open and work on projects regardless of what version of Automation Studio

they are using. This can help streamline project delivery while allowing improved collaboration across organizations and teams, eliminating the need for parallel installation of multiple versions. It also helps to prevent obsolescence, as legacy systems can be more easily updated with new programming.

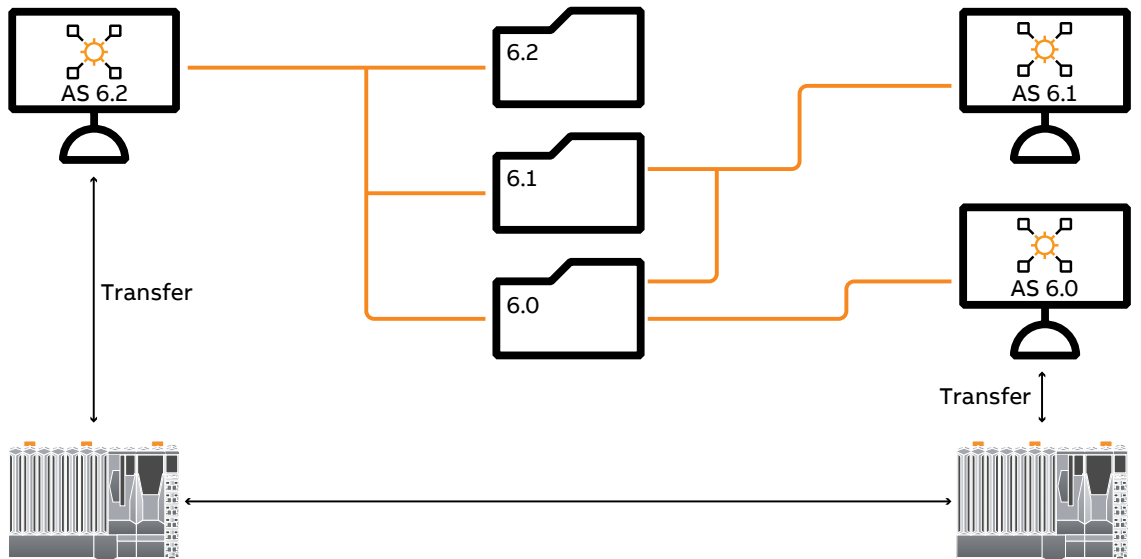

02

⊕ BENEFITS FOR MACHINE BUILDERS

- More intuitive interface
- Reduced project complexity
- More productive collaboration
- Easy machine maintenance

⊕ BENEFITS FOR MANUFACTURERS

- Faster installation and commissioning
- More efficient service
- Less downtime

Effortless quality with the mapp Framework

mapp Technology revolutionized the development of automation software by enabling engineers to complete their work up to three times faster. The mapp Framework now provides a universal starting point for mapp Technology with a collection of ready-made programming tasks and configuration files that makes software development faster and easier than ever.

01 Using mapp Technology reduces total programming effort. Implementing mapp Technology with the mapp Framework reduces it even further.

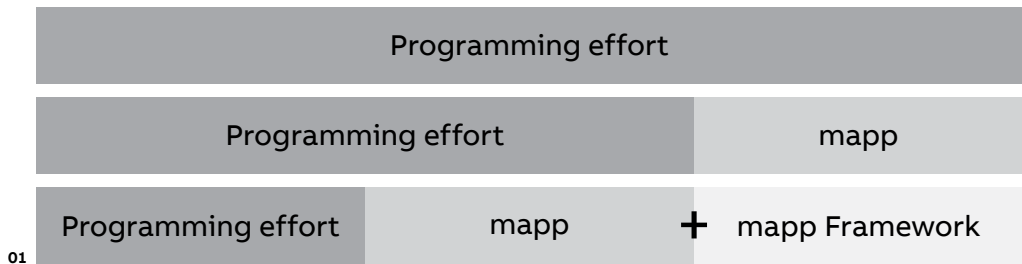

The mapp Framework takes the benefits of mapp Technology to a new level with a further dramatic reduction in the amount of code that application engineers must write. As an open-source and community-driven resource, it is based on the experience of B&R's engineers and customers around the world. Best practices and expert know-how are built in for high quality. Feedback and requirements from the development community are fed directly into ongoing improvements, giving users a strong voice in how it evolves.

Universal starting point for mapp Technology

The framework provides a universal starting point for mapp Technology via a collection of ready-made programming tasks and configuration files. Engineers can import a functional mapp Services or mapp Axis implementation into their Automation Studio project with just a few clicks via an easy-to-use import wizard. The modular design makes it easy to add only the specific parts of the framework that are relevant to the machine. By accelerating development, the mapp Framework lowers software costs and shortens the time to market for new machines.

About mapp Technology

mapp Technology is the overarching term for B&R's ready-made, modular software products. It enables users to implement complex or tedious features (such as a recipe system) simply by configuring a few drag-and-drop components. They can complete their application up to three times faster and using significantly less code than if they wrote it entirely with PLCopen.

⊕ BENEFITS FOR MACHINE BUILDERS

- Faster time to market
- Higher code quality
- Reduced engineering costs

⊕ BENEFITS FOR MANUFACTURERS

- Higher code quality

Tutorial playlist:



Download mapp Framework:





Open connectivity out of the box



Support for OPC UA Alarms and Conditions (A&C) is now integrated directly in the real-time operating system. With mapp AlarmX OPC UA A&C, machine builders now have a high quality out-of-the-box component that lets them set up the necessary connectivity with just a few clicks.



Machines with mapp AlarmX can be easily turned into an OPC UA A&C server that shares the list of alarms in accordance with all the applicable standards. Any OPC UA A&C client can be used to aggregate alarms from multiple OPC UA A&C servers. mapp View HMI applications on the machine act as an OPC UA client, making use of the alarms provided by the real-time system to implement fast, efficient reactions directly at the machine level.

The key to IoT services

OPC UA makes it possible for all the machines in a plant to share information (such as alarms) in a communication protocol that can easily be understood by higher-level systems. This is the key to implementing advanced Industrial IoT services and AI-based functions such as predictive maintenance and OEE optimization.

⊕ BENEFITS FOR MACHINE BUILDERS

- Reduced engineering costs
- Competitive machine features
- Competitive service capabilities

⊕ BENEFITS FOR MANUFACTURERS

- Faster time-to-market
- Easy multi-vendor integration on the shop floor
- Superior performance and usability

Free choice of simulation tool

B&R has added a new function to its Automation Studio development environment. With FMU Export, machine code can be exported and integrated as a PLC simulation into any simulation tool, allowing simulation experts to work in the familiar software ecosystem of their choice. This saves both valuable time and resources during interdisciplinary development.



All necessary data is automatically bundled into a Functional Mock-up Unit, or FMU. Because the exported FMU incorporates a standardized interface, there is no need to create a new interface for each tool. The only requirement on the tool side is support for the FMI 2.0 standard. FMI stands for Functional Mock-up Interface, an industry-independent standard for exchanging models between different modeling tools.

Data exchange in both directions

It was already possible to import machine models into Automation Studio using FMU Import. Now developers can also export their machine code to the simulation tool of their choice. FMU Export is available to all Automation Studio users starting with Automation Studio 4.12.

01 Complete Automation Studio projects can be exported to a variety of simulation tools at the touch of a button.

02 Developers can now export their machine code from Automation Studio to the simulation tool of their choice.

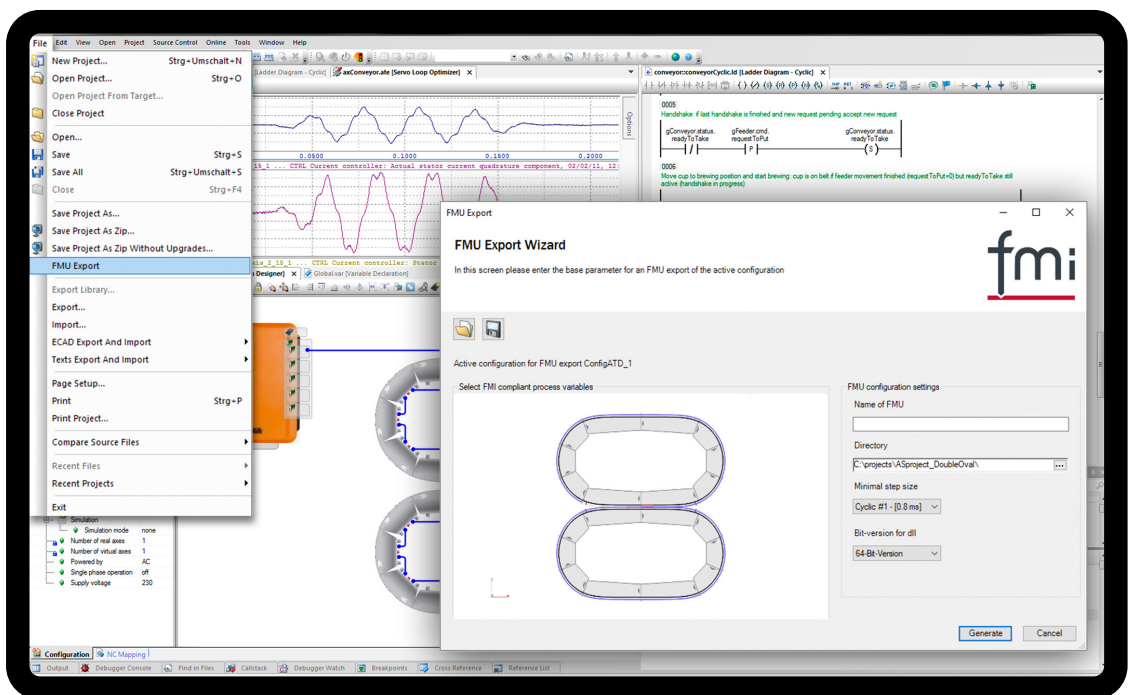

01



02



Co-simulation



Potential for innovation

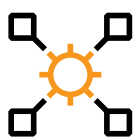

Automation Studio

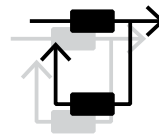

Model-based development

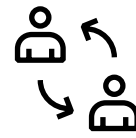

Synchronized engineering

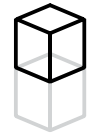

Digital twin

⊕ BENEFITS FOR MACHINE BUILDERS

- Increased productivity
- Shorter time to market
- Easy collaboration in interdisciplinary teams

⊕ BENEFITS FOR MANUFACTURERS

- Increased reliability of machine application
- Quicker line setup and configuration

Compact high performance

High-performance control applications can now be implemented even more cost-effectively while also taking up less space. This is because B&R has added a high-performance variant to its compact X20 Embedded PLC family.

01 The compact controller can even replace industrial PCs in some applications.

02 The C20EM1613 variant can be expanded with an interface module for additional communication protocols.



The X20EM0613 and X20EM1613 PLCs enable cycle times of 100 μ s, making them twice as powerful as previous variants. And this is possible with a housing width of just 55 mm, which saves machine builders valuable space in the control cabinet.

These new controllers come standard with two USB ports, integrated flash memory and two Ethernet interfaces. An integrated switch supports daisy chaining, alleviating the need to purchase any additional network components.

Integrated interfaces

The compact housing includes hardware interfaces for both POWERLINK and RS485. The RS485 interface can be used to connect devices such as

frequency inverters to the PLC without any additional interface cards or I/O modules. Since the power supply is also integrated, a separate power supply module is not required.

Additional fieldbus protocols can be added with an optional interface slot. X20 Embedded devices are compatible with all B&R interface and X20 I/O modules.

No maintenance costs

X20 Embedded PLCs are designed for everyday operation in harsh industrial environments. They can be used in a temperature range of -25°C to +60°C and have no fans or other moving parts. That reduces maintenance costs and effort for machine operators.





⊕ BENEFITS FOR MACHINE BUILDERS

- Low cost, high performance
- Reduced cabinet footprint
- Power reserves for later upgrades
- Fully scalable portfolio for all requirements

⊕ BENEFITS FOR MANUFACTURERS

- Full industrial-grade equipment
- No maintenance costs
- Withstand extreme temperatures



02

Technical data	X20EM1613 / X20EM0613
CPU	1.3 GHz
Shortest cycle time	100 μs
RAM	1 GB
Integrated flash memory	2 GB (eMMC)
Ethernet (switch)	2x 10/100 BASE-T
Integrated interface	RS485
USB 2.0	2x
Interface slots	1 / 0
Temperature range	-25°C to +60°C





Secure from sensor to cloud with OPC UA FX

With its new bus controller for OPC UA FX, B&R is making the implementation of IoT projects easier than ever. This device is the first of its kind equipped with built-in security mechanisms for communication from the field level to higher-level IT systems.

The X20BC008T bus controller offers integrated certificate handling and is thus one of the first field devices to meet the security requirements of advanced IT systems. This is the key to enabling true IT/OT convergence and many IoT applications.

Simple integration

Thanks to the OPC UA standard, the bus controller can be used along with other OPC UA devices in multi-vendor environments. Depending on requirements, either the high-performance TSN real-time mechanisms with

publisher/subscriber communication or a classic client/server connection can be used. Both of these models can also be used at the same time.

Equipped for the future

Integrating TSN mechanisms and gigabit physics, the TSN-capable bus controller is equipped to meet not just the needs of today's applications, but those well into the future as well. Acting as an OPC UA server, the device automatically provides all information from connected I/O modules to OPC UA clients from any manufacturer in real time.

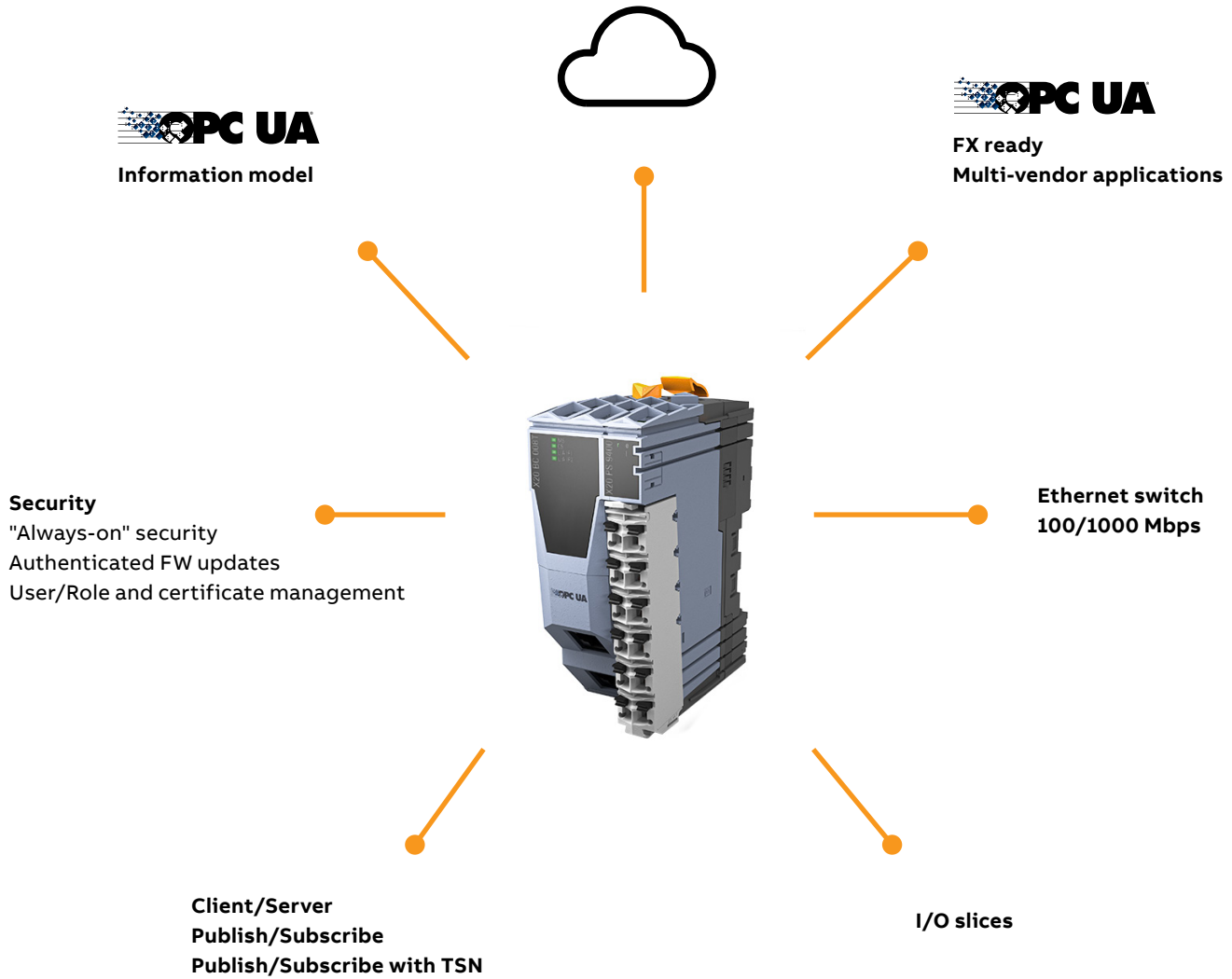

01

01 OPC UA FX will be the foundation of many IoT projects in the future.



**⊕ BENEFITS FOR
MACHINE BUILDERS
AND INTEGRATORS**

- Easily equip machines with IoT functions
- Open up entirely new business models
- Vendor-independent standard
- Improved competitiveness

**⊕ BENEFITS FOR
MANUFACTURERS**

- Easy implementation of IoT applications
- OPC UA as universal language
- Lower costs for IoT applications
- Free interoperability in the factory

Always the right connection

In addition to POWERLINK, Ethernet, USB and RS232, B&R is now equipping its compact controllers with an integrated RS485 interface. Frequency inverters and other devices can be controlled directly, without requiring an additional I/O module for the interface. Machine builders save both costs and cabinet space.

01 In a width of only 37.5 mm, B&R's Compact-S PLC series offers POWERLINK, Ethernet, USB, RS232 and RS485. Optional interface slots open up the entire range of X20 fieldbus interfaces.

02 The modular three-part design offers scalable performance and connectivity.



There is no such thing as a single controller that is suitable for all automation tasks – it would be too expensive to pay for the technical overhead in many applications. Smaller systems in particular require controllers that provide the right amount of performance along with the ability to upgrade if necessary – all while being cost optimized. With its Compact-S series, B&R offers a family of controllers that match these requirements exactly.

Compact and communicative

B&R has developed a new bus base that can be used to add an RS485 interface to all existing Compact-S controllers. This makes it possible to connect a frequency inverter via Modbus without the need of an additional interface card. This has been accomplished without impacting other specifications. At a width of only 37.5 mm,

including the power supply, these controllers are the most compact in their class. Featuring POWERLINK, Ethernet, USB, RS232 – and now RS485 – the different variants of this controller offer a wide range of communication options. A CAN interface is also available as an option, also without increasing the size.

If the application requires additional interfaces, the controller can be expanded by an X20 interface slot. This opens up the entire product range of fieldbus interfaces and I/O modules from the X20 series. The RAM and computing power of the Compact-S controller also adapt to the application requirements. This makes it possible to find the perfect controller for a wide range of small and medium-sized automation applications.



1

Bus base
with RS232
with CAN
with RS485

2

PLC unit
scalable performance
7 different variants

3

Power supply
for PLC and I/O



02

⊕ BENEFITS FOR MACHINE BUILDERS

- Integrated RS485 interface
- Reduced costs
- One device for any interface

⊕ BENEFITS FOR MANUFACTURERS

- No technical overhead
- Smaller control cabinet

Four times more performance with X2X+

B&R now offers the X2X+ backplane bus as an option, increasing the performance of the X20 system by a factor of four. And because all existing X20 I/O modules are already compatible with X2X+, all it takes to build more powerful machines are bus modules.

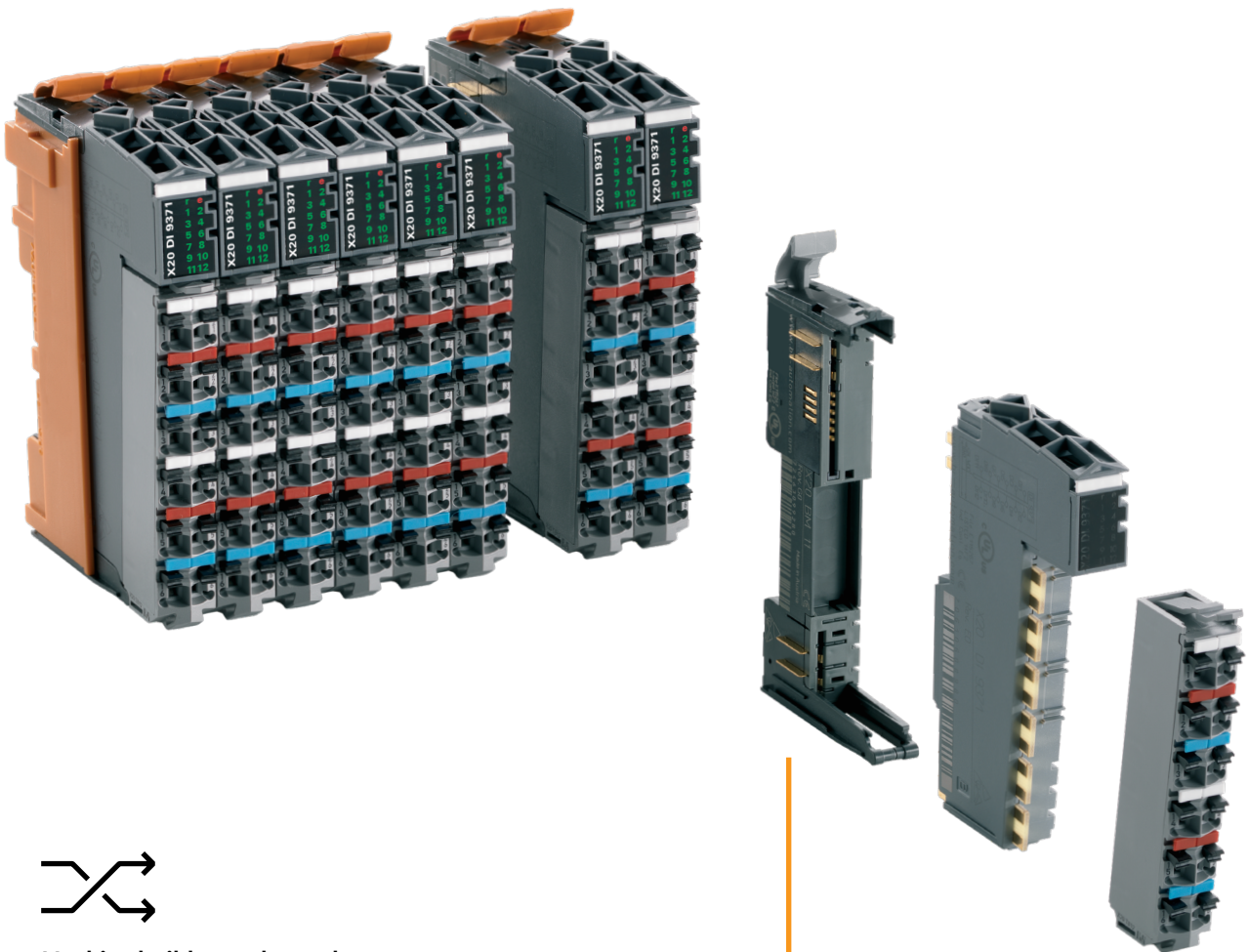

Machine builders only need to use a new backplane module to benefit from the performance boost of the new X2X+ backplane bus.

01 X2X+ is compatible with all existing X20 I/O modules.



The advantages of this new bus are particularly apparent in applications that involve many I/O modules or high data volume but where short cycle times are imperative. It is even possible to set up two separate cycle times so that less time-critical data is transported more slowly and generates less network and processor load. In this way, complex high-speed processes can be controlled reliably using cost-effective standard hardware.

High sampling rates

X2X+ enables faster data transfer and up to four times faster response times. In combination with this higher bandwidth, large amounts of data can be handled better and higher sampling rates can be achieved. This is an advantage when measuring vibration, for example, and results in more accurate condition monitoring across the board.

More than 100 I/O modules in 200 μ s

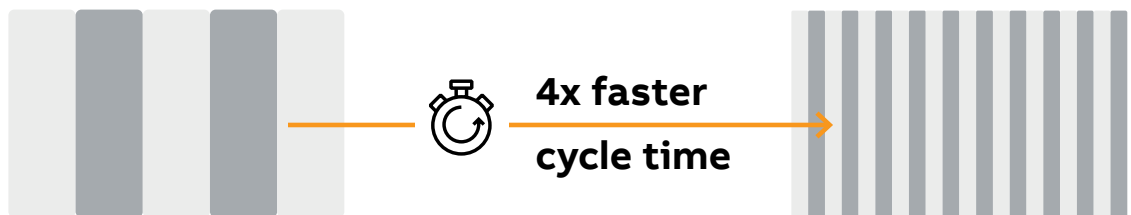

⊕ BENEFITS FOR MACHINE BUILDERS

- More performance
- Faster response times
- Fully compatible with the existing X20 portfolio

⊕ BENEFITS FOR MANUFACTURERS

- Increased productivity
- Higher resolutions for more accurate analyses
- More accurate condition monitoring

Automation PC 4100 makes applications future proof

Industrial machines and their software are becoming increasingly complex and data intensive. With the new Automation PC 4100, B&R answers the call for a compact, future-proof industrial PC with high-end power.



01

01 Alongside the APC2200 and APC3100 (right and center), the APC4100 (left) rounds out the top end of the B&R industrial PC lineup.

02 Every Automation PC 4100 is custom assembled, tested under full utilization of all interfaces and can be delivered ready to use.

The successor to the popular APC910 can be individually tailored to customer requirements. It delivers an impressive combination of proven features and the latest PC technology with customizable CPU performance. PCI Express cards and especially compact interface options make it easy to adapt B&R industrial PCs to nearly any application. Even after installation, retrofit options remain open throughout the device's service life for maximum investment security.

Innovative machine functions

Digitalization relies on powerful industrial PCs, not only for computationally intensive machine learning algorithms, vision applications and digital twins, but also for innovative logistics, quality assurance and manufacturing solutions. The Automation PC 4100 was specially developed for these demanding applications.



Scalable performance

CPU performance ranges from Celeron up to Xeon and can thus be adapted to any application. The main memory can be expanded up to 64 GB RAM and also supports ECC (error correction code). In addition, depending on the selected housing size, up to three PCI Express cards can be added. This makes it possible to implement complex graphics applications with 3D animations, camera systems or fieldbus extensions. Fieldbus interface modules, an uninterruptible power supply or additional Ethernet interface can also be integrated after installation.

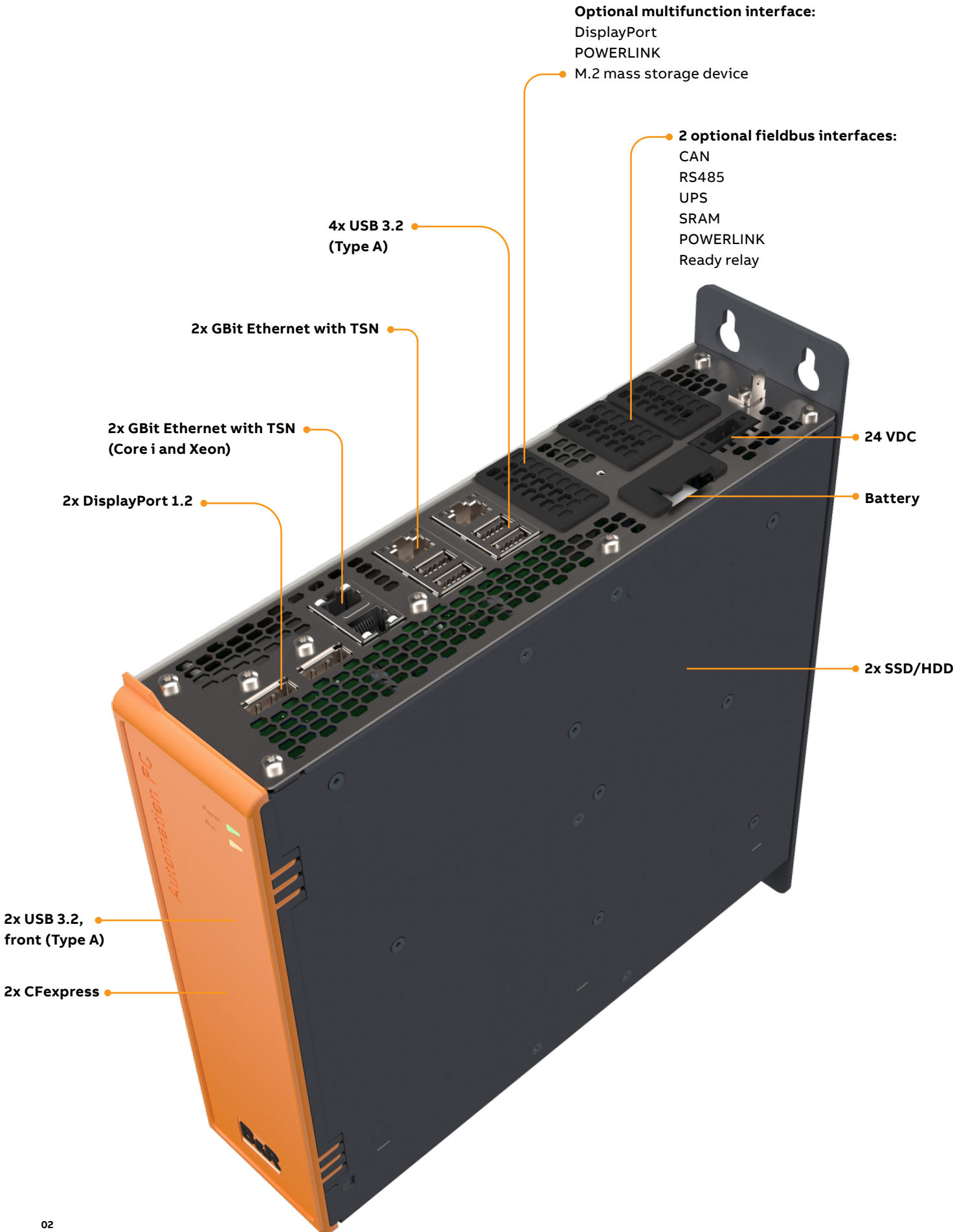

Custom configured and ready to go

Each Automation PC 4100 is custom assembled, tested under full utilization of all interfaces and can be delivered ready to use with customer-specific software and images pre-installed. The BIOS settings can also be configured according to user

specifications and intended use. Custom front covers, customer-defined material numbers or operating system images enable each customer to adapt their PC to their individual needs and logistics processes.

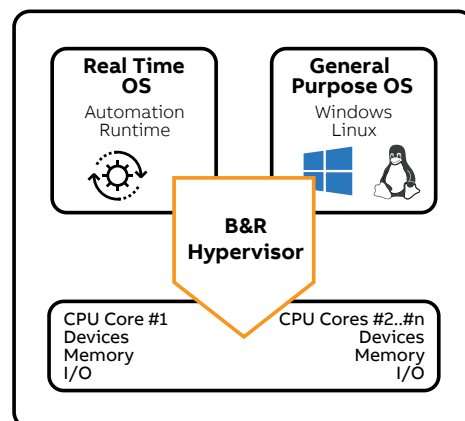
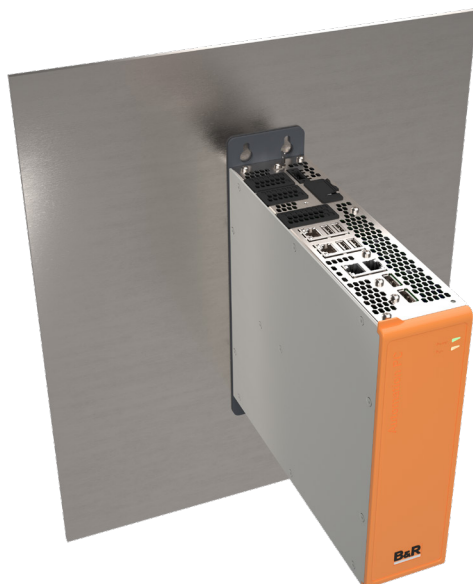

01

01 B&R Hypervisor enables parallel use of both real-time and general purpose operating systems on one PC. This lowers costs and frees up valuable cabinet space.

02 The APC4100 was specially developed for the high demands of machine learning, vision and digital twins as well as innovative logistics, quality assurance or manufacturing concepts.

Technical data	Automation PC 4100
Sizes	0/1/2/3 slots (PCI/PCI Express)
Processors	Celeron 660HLE 2 cores 2.1 GHz Core i3 11100HE 4 cores 2.4 GHz Core i5 11500HE 6 cores 2.6 GHz Xeon 11155MRE 4 cores 2.4 GHz Xeon 11865MRE 8 cores 2.6 GHz
RAM (incl. ECC)	Up to 64 GB of DDR memory
USB 3.2 (type A)	6x
Ethernet 10/100/1000 (with TSN support)	4x (Celeron 2x)
CFexpress	2x
2.5" HDD/SSD	2x (optional)
M.2	1x (optional)

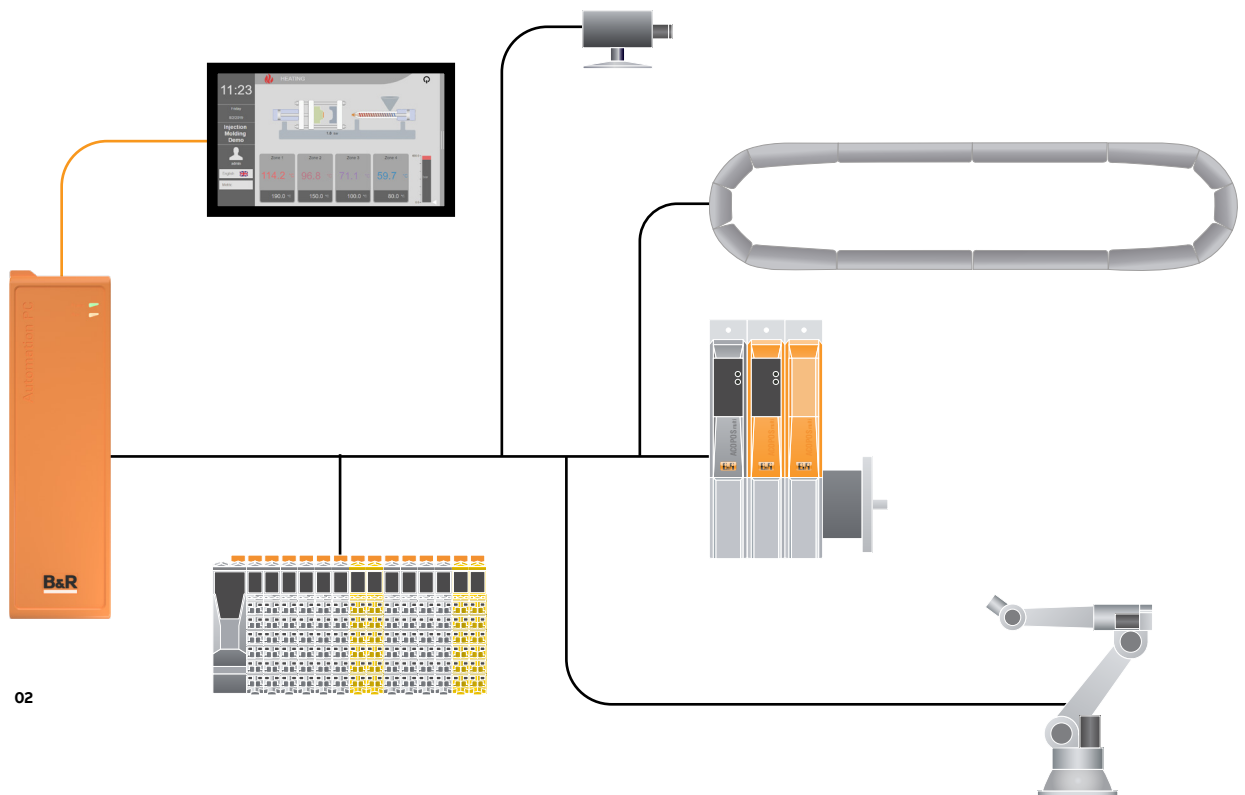

02

Specially designed for industrial applications

Equipped with B&R's own real-time operating system, Automation Runtime, the APC4100 can also be used as a high-performance controller for complex machines and plants. With Windows or Linux operating systems, the APC4100 can function as an edge controller, preprocessing large amounts of data and then forwarding the collected data to a cloud application.

Thanks to its robust design, especially with the fanless variants, the APC4100 ensures years of virtually maintenance-free 24/7 operation even under harsh operating conditions. The standard operating system used is Windows 10 IoT Enterprise, with ten years of support and availability. Since the dimensions are comparable with the predecessor model APC910, retrofit solutions are also easily possible, for example when plant expansions require higher performance.

⊕ BENEFITS FOR MACHINE BUILDERS

- Freely configurable
- Future proof
- Ready to use
- Retrofit ready

⊕ BENEFITS FOR MANUFACTURERS

- Performance tailored to application
- Scaled and configured for optimal cost
- Long lifespan, maintenance free
- Custom expansion

Fast and flexible HMI design

B&R's mapp View HMI design software introduces new user interface design templates and a Widget Development Kit that make creating HMI applications faster, easier and more flexible than ever.



01

01 A well-designed HMI system makes users more efficient and productive. New mapp View UI templates offer professional design right out of the box.

02 The Widget Development Kit gives developers the flexibility to create custom UI elements that give the machine a competitive edge.

Fast and professional

A well-designed HMI system doesn't just look good, it guides users intuitively through their daily tasks, making them more efficient and productive. mapp View now includes a collection of user interface templates that offer professional design quality right out of the box.

The new templates make it easier for automation engineers to benefit from the full potential of what mapp View has to offer, even without specialized UI/UX training. The templates incorporate best practices and deliver high quality results

quickly. Faster HMI development means faster time to market for the entire machine.

The templates include a set of layouts, pages, visualization logic, icons, fonts and styles. After dragging and dropping the template into the Automation Studio project, a wizard guides the user through a fast and intuitive customization process that adapts the template to the application's needs: navigation tree, color palette and more. After that, they simply connect data and modify inputs. The machine's modern, user-friendly HMI software can be ready in a fraction of the time.



02

Flexible and powerful

With a graphical editor and out-of-the-box widgets, mapp View is designed to make modern web-based HMI functionality accessible to automation engineers who don't have special training in web technology. With the Widget Development Kit, B&R now offers greater flexibility for machine builders who have their own in-house web development team or use a third-party partner. It is now easy for them to integrate custom widgets created by professional web developers into mapp View applications.

Custom widgets can be used alongside B&R's standard mapp View widgets, so every engineer on the team has the right tools for their needs. Web developers have the flexibility to create cus-

tomized charts, lists, buttons and animations to solve specific tasks and set the machine apart from the competition. Automation engineers continue to enjoy the convenience of using the standard mapp View programming tools inside B&R's Automation Studio engineering environment.

The Widget Development Kit speeds up access to new features and provides more freedom to optimize the performance of complex UI elements. Instead of combining multiple B&R widgets to accomplish a certain task, a user can create their own widget that is trimmed and optimized for their specific needs. Customers' intellectual property is encapsulated in future-proof components that can easily be converted to other web platforms.

⊕ BENEFITS FOR MACHINE BUILDERS

- Faster time to market
- Higher code quality
- Reduced engineering costs
- No specialized training needed

⊕ BENEFITS FOR MANUFACTURERS

- More intuitive operation
- Increased operator safety
- Better machine performance

Get moving faster with standby mode

B&R is introducing the X90CP150 to its portfolio of mobile automation systems. Not only does this new compact controller have an optimized price per I/O, it is also equipped with standby mode, making it ready to use in a fraction of a second. This allows many more applications to benefit from the advantages of B&R's integrated automation technology.

01 B&R is expanding its controller portfolio for mobile machinery with the X90CP150.



The CP150 expands B&R's broad portfolio of IP69K controllers for machines operated in harsh environments, such as off-highway commercial vehicles and heavy equipment. Ranging from the X90CP150 at the economy end of the spectrum to the powerful high-end Mobile PC 3100, machine builders benefit from a perfectly harmonized automation system where development, diagnostics and commissioning can all be handled with a single software tool.

Full flexibility

Since the software is independent of the hardware, it is easy to switch to more powerful hardware whenever additional functions become necessary. Downgrading for cost-sensitive markets is just as easy. The existing software can still be used.

Technical data	X90CP150
Processor	ARM Cortex A9-650
RAM	512 MB
ROM	1 GB
Integrated I/O	60
Safe I/Os (optional)	Up to 48
Interfaces	Ethernet 10/100, CAN, LIN, USB, POWERLINK (optional)
Protection	IP69K

Uniform brand identity

Customized logos and serial numbers are now possible on all components in the B&R mobile automation portfolio. This allows mobile machinery manufacturers to strengthen their brand identity and protect their intellectual property.

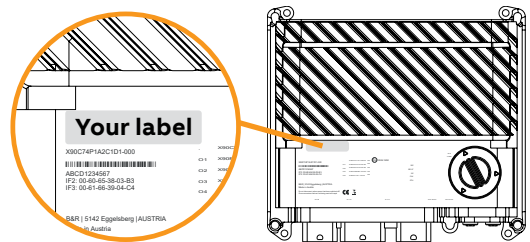

Fast

Ready for use in a fraction of a second

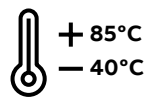
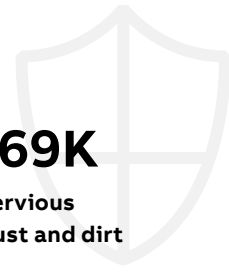
**IP69K**Impervious
to dust and dirt

01

Flexible

60 integrated multifunction I/Os

Safe

Optional safety variant

⊕ BENEFITS FOR MACHINE BUILDERS

- Optimized costs
- Uniform automation system
- Easy upgrades and new features

⊕ BENEFITS FOR MACHINE USERS

- Always ready
- High performance
- Smart and connected

The keys to smooth operation

B&R is expanding the range of applications for its Power Panel T50 mobile. This robust operator panel responds faster to input from external keys, provides additional certificates and can withstand even lower temperatures.

01 Mobile machines can now be operated even more conveniently.

02 Operator keys can now be connected directly to the Power Panel T50 mobile via digital inputs.

B&R's mobile operator terminal just got even more user friendly. Input with tactile feedback is now processed directly on the terminal without latency. Since the automotive connector can be used to connect operator keys directly via four digital inputs, the input no longer needs to be transferred via the machine network.

The T50 mobile is also UL certified. This makes importing the device to the US much easier. And, the operator panel can now withstand temperatures as low as -30°C during transport, increasing logistical options and reducing international shipping costs.



Technical data	T50 mobile
Sizes	5", 7", 10.1"
Protection	IP67
Operation	Multi-touch
Interfaces	Ethernet 10/100, USB

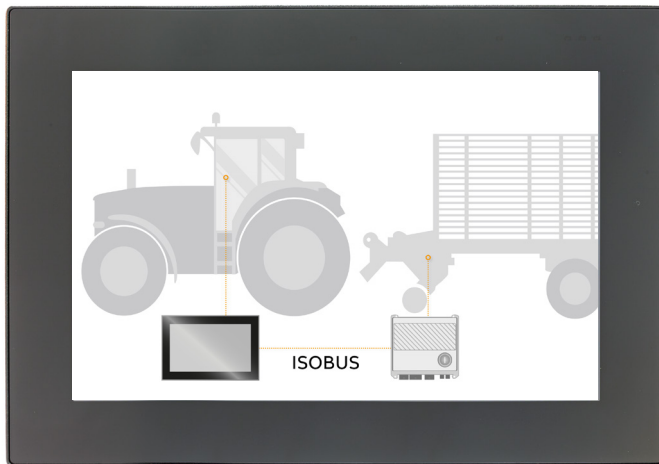



02

mapp
VIEW

⊕ **BENEFITS FOR
MACHINE BUILDERS**

- Wider range of applications
- Easy shipping to the customer

⊕ **BENEFITS FOR
MACHINE USERS**

- Smooth operation
- Tactile feedback during operation

Paving the way for Smart Farming and Smart Construction

I/O modules and sensors can now be connected directly to the Automation PC 3100 mobile. The device can be used both as a high-performance embedded controller and as a PC. B&R Hypervisor makes it easy to combine both functions and implement advanced IoT applications in construction and farming.



The Automation PC with up to IP69K protection could already be used for computationally intensive tasks on mobile machines, for example as an edge controller to preprocess data and transfer it to the cloud. The new option boards make it possible to integrate the PC into POWERLINK and CAN networks and use it as a controller. This makes it easy to combine sensors from different manufacturers in a single automation system.



Shorter development time

The Automation PC 3100 mobile is the ideal foundation for connecting smart mobile machines to Industrial IoT solutions. Machine operators benefit from more efficient machines. Manufacturers of mobile machinery can implement their automated processes via a single system which includes everything from sensors to cloud connectivity. This saves costs and valuable development time.



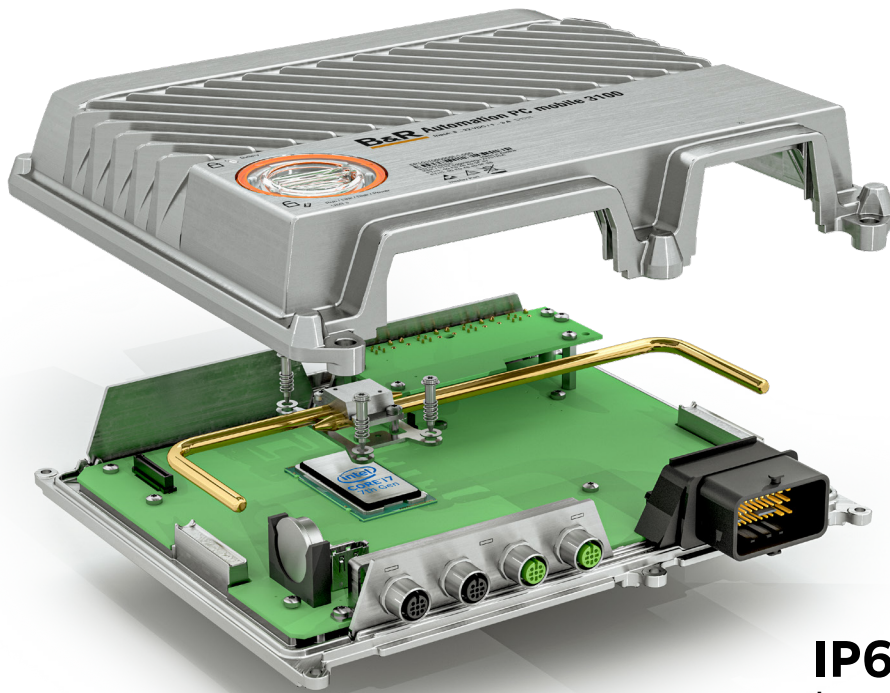

IP69K
Impervious
to dust and dirt

02

01 The Automation PC 3100 mobile makes it easy to implement smart farming solutions.

02 The Automation PC 3100 mobile provides sufficient performance for demanding IoT applications.

Technical data	Automation PC mobile 3100
Processors	Intel Celeron to Core i7
RAM	Up to 16 GB
ROM	Up to 480 GB
Slots for option boards	2
Interfaces	Ethernet 10/100, USB, CAN, RS422/485, RS232
Protection	IP69K

⊕ BENEFITS FOR MACHINE BUILDERS

- Single uniform system
- Short time to market
- Future proof
- Enhanced control capabilities

⊕ BENEFITS FOR MACHINE USERS

- Efficient machines
- Plenty of power for future upgrades
- Ready for smart farming and construction

Sustainable performance under changing conditions

With three new motion control functions, B&R helps machines last longer and use less energy. By detecting changes in load at runtime and optimizing parameters accordingly, they minimize sources of vibration throughout the control loop. Machine builders no longer need to compensate with oversized mechanical components, so they can save hardware costs and build a more compact machine.

01 The jerk changes depending on the system acceleration. It is not limited and can exceed the maximum mechanical limit of the system.

02 The system ensures that the maximum jerk limitation will never exceed the mechanical limit, in this example 500,000 Units/s².

03 When the load changes, the system automatically changes filter parameters.

Jerk Filter:
Jerk time = 0.1s

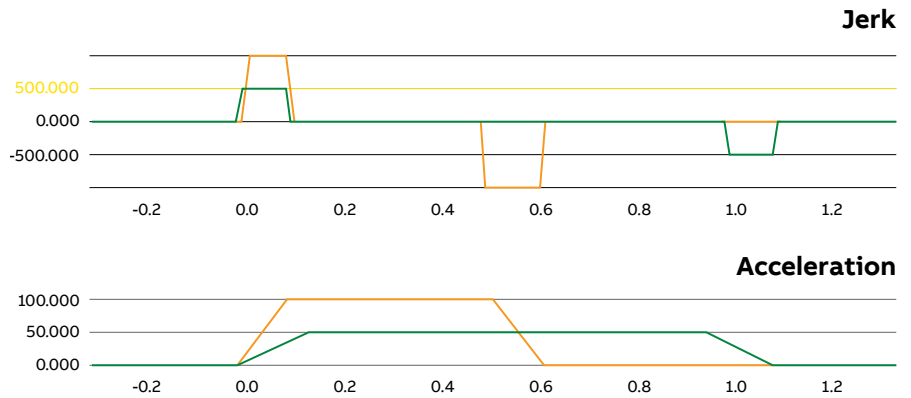

Jerk Limitation:
Jerk = 500 Units/s³

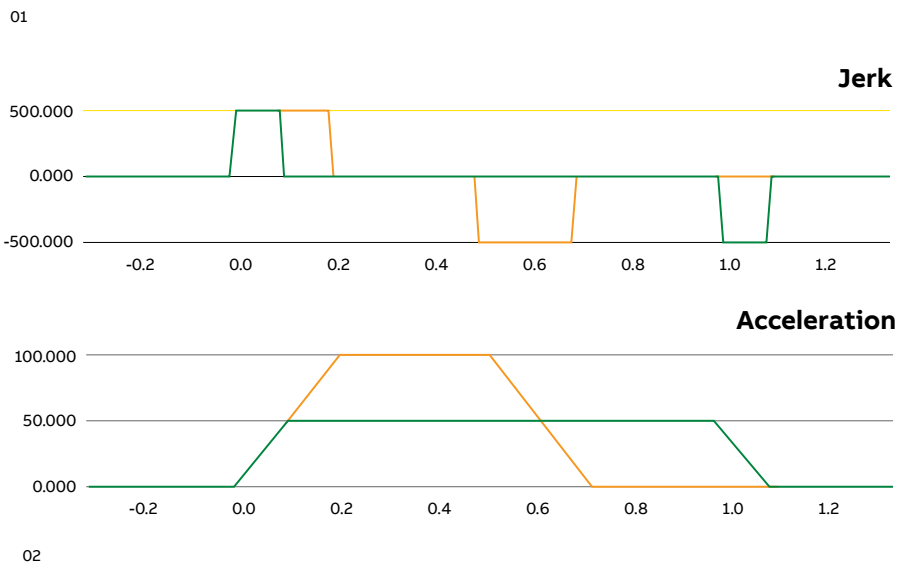

Acceleration: 50 Units/s² | 100 Units/s²

Smooth move

B&R's mapp Axis software component now features jerk-limited trajectory planning. Jerk limits can be set for each axis and adapted automatically during movement to minimize vibrations. This is particularly beneficial in highly dynamic systems. Reduced vibration not only makes the machine faster and more precise, it also makes it run a lot more quietly.

Save time

ACOPOS drives now feature an adaptive notch filter, which adjusts automatically when there is a change in the mass being moved. When an axis returns to a starting position after moving a load, for example, applying the same notch filter during loaded and unloaded movement would cause high frequency vibrations. The result would be losses in the motor and undue wear on

mechanical components. With the adaptive notch filter controller parameters can be optimized in a way that guarantees maximum performance over a wide range of loads.

Smart sensor

The passive feed-forward function is effectively a smart virtual sensor with a multitude of potential uses. For example, by constantly monitoring changes in inertia, it enables control parameters to be optimized for handling products of different weights. It also makes it possible to identify changes over the lifetime of the machine that indicate component wear. Machine builders are able to implement predictive maintenance and inform their customers proactively when replacement parts are required. Manufacturers enjoy increased productivity and consistent product quality while also minimizing energy consumption.

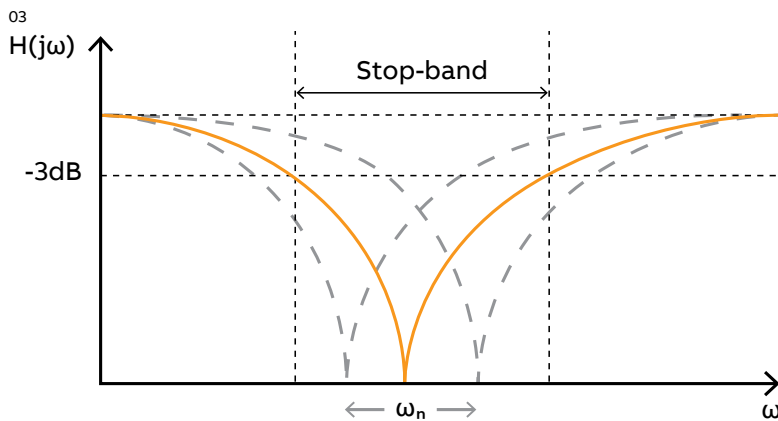

⊕ BENEFITS FOR MACHINE BUILDERS

- Lower hardware costs
- Higher machine performance

⊕ BENEFITS FOR MANUFACTURERS

- Reduced energy consumption
- Extended service life
- Less downtime and more productivity

Smart motion control does more with less

As companies in all industries face rising energy costs and seek to improve sustainability, B&R offers new ways to get more performance while using less power. Continuous innovation in smart motion control is the key to sustaining industrial growth while staying on the cutting edge of energy efficiency.



01 Instead of being released as heat, kinetic energy generated during braking is converted to electrical energy that is regenerated into the power supply system.

30% less power loss

With a new pulse-width modulation (PWM) function, ACOPOS P3 servo drive automatically reduces its switching frequency at a given motor speed to limit power dissipation. Automatic adaptive PWM reduces power consumption of the ACOPOS P3 by as much as 30% at low motor speeds or in standstill operation. There is no need to oversize the servo drive to prevent overheating when holding heavy loads. With smaller servo drives and less cooling equipment needed, this helps reduce the size of the control cabinet for a smaller machine footprint.

1st class energy efficiency

B&R's energy efficient motors have enabled it to become one of the very few suppliers to certify its entire motor portfolio according to Class 1 of the China Energy Label (CEL). CEL certification is essential for OEMs who wish to sell their machines in China. It also makes it easier and more transparent for users around the world to compare energy performance between machines.



21% more torque for the same power

The new ACOPOSmulti inverter 200 A offers a 21% increase in servo drive output current for the same amount of consumed power. This is important in applications that require high torque output at low speed, such as in the production of silicon wafers for solar panels. With the new ACOPOSmulti inverter, it is possible to slice bigger wafer diameters while also saving energy costs. Wafers account for a significant portion of PV cell production cost, so making them more efficiently helps lower the cost of this important source of renewable energy.



Best-in-class torque density

B&R's new high torque density motors have an optimized internal design to reduce power losses and increase torque. Machine builders can fit more torque in less space. Manufacturers enjoy reduced motor cogging for better accuracy and improved product quality, as well as reduced heat generation.

01

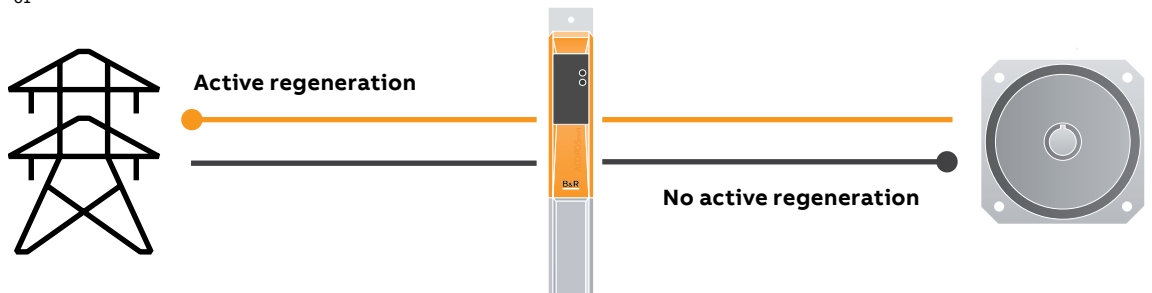

⊕ BENEFITS FOR MACHINE BUILDERS

- Smaller components, better performance
- Reduced hardware costs
- Competitive advantage

⊕ BENEFITS FOR MANUFACTURERS

- Energy savings
- Increased productivity
- Reduced machine footprint

Fast and gentle transport

Anti-sloshing is now an integrated feature in the firmware of all B&R motion control systems. Not only track systems, but all other ACOPOS-driven axes can now carry containers of fluids and powders more gently without turbulence. This increases productivity while at the same time reducing waste and wear.



Until now, anti-sloshing has been a software function available for SuperTrak and ACOPOStrak systems. With the new firmware implementation, it is now available for standard ACOPOS systems as well, such as conveyor systems driven by a rotary motor. Users can easily configure anti-sloshing for different container shapes and liquid densities, allowing them to transport liquids at higher speeds with minimal turbulence. Not only do more gentle movements avoid spilling, they also reduce wear on the machine's mechanical components.

Easy and adaptive

ACOPOS anti-sloshing automatically applies the right algorithm for each shape and speed, making it easier to implement adaptive manufacturing solutions with frequent changes between batches of different products and containers. Machine builders do not have to spend development time and effort implementing separate profiles to compensate for different types of containers. Machines achieve higher performance with better quality and less waste.





⊕ **BENEFITS FOR
MACHINE BUILDERS**

- Optimized mechanics
- Reduced development time
- Performance edge

⊕ **BENEFITS FOR
MANUFACTURERS**

- Less downtime for cleaning
- Less waste, higher quality
- Reduced wear and maintenance

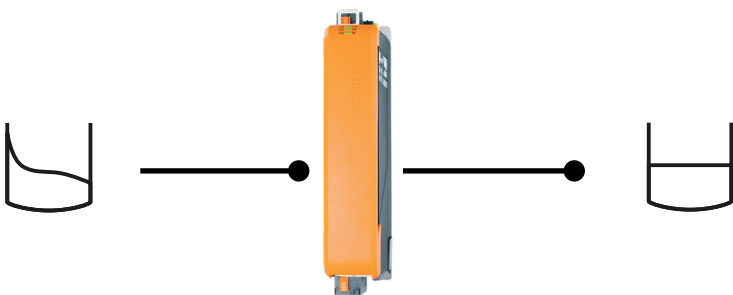

● **Anti-sloshing**

Keep it together and prevent damage

Autonomous movement generation enables B&R servo drives to execute a movement profile in the event of an unexpected loss of PLC communication. When using an ACOPOS P3, that means up to three axes can be brought to a synchronized stop, preventing costly damage and allowing for a quick return to productivity.



mapp
AXIS

Most industrial machinery has mechanical components whose movement needs to be synchronized to avoid dangerous collisions. If the motion control system relies on movement profiles coming from the PLC, an unexpected loss of communication could result in uncontrolled movements that endanger operators and damage equipment. In addition to the cost of replacing damaged hardware, hours or days of productivity would be lost while waiting for parts and making repairs.

Safely synchronized

B&R servo drives automatically detect PLC or fieldbus failure and go into a user-defined fallback state. In this state, any type of movement profile can be triggered and up to three axes connected to the same ACOPOS device can be brought to a synchronized stop in a desired end position. Autonomous movement generation perfectly complements B&R's SafeMOTION safety functions and can trigger safe movements even without a connection to the PLC. With no additional sensors or restrictive mechanical links required, machine builders have more freedom to design flexible, adaptive machines.

Use case: Wind turbine

The high cost of downtime in wind turbines make them a prime candidate for benefiting from this function. For example, damage to the slip ring between tower and nacelle could interrupt fieldbus communication to the blades. In this case, an ACOPOS P3 could stop the blades in a safe position and prevent more severe damage.

Use case: Valve operation

Large valves can take several minutes to close after being triggered. If fieldbus communication is lost during this time, autonomous movement generation can ensure the valve doesn't stop in a partially closed position that could result in serious damage or injury.

⊕ BENEFITS FOR MACHINE BUILDERS

- No additional sensors or mechanical links
- Safety certification valid even when communication lost

⊕ BENEFITS FOR MANUFACTURERS

- Improve operator safety
- Prevent equipment damage
- Quickly resume production



Never overload another gearbox

ACOPOS drives now ensure that motor operation remains within the specified limits for the gearbox. This eliminates the risk of damaging the gearbox with excessive speed or torque. Preventing premature gearbox failure means less downtime for unexpected maintenance.



B&R's ACOPOSmulti and ACOPOS P3 servo drives can now read the maximum speed and torque values of connected gearboxes. This allows them to ensure that the motor stays within the specified limits to avoid unnecessary fatigue and risk of premature gearbox failure. Machine builders no

longer have to compensate by installing an oversized gearbox, saving them unnecessary costs and allowing them to build more compact machines. Protecting the gearbox also protects the output shaft and prevents damage inside the machine.

⊕ BENEFITS FOR MACHINE BUILDERS

- Reduced hardware costs
- Reduced gearbox size and space requirements
- More reliable machines

⊕ BENEFITS FOR MANUFACTURERS

- Reduced risk of premature gearbox failure
- Prevention of unexpected downtime
- Smaller machine footprint



Faster to the perfect drive solution with MATLAB/Simulink

B&R has made it much easier to develop and optimize machines using the MATLAB/Simulink simulation tool. This is because B&R drives and motors can now be tested and optimized directly within the simulation environment. Additional tools are not necessary, and overall development time is reduced.

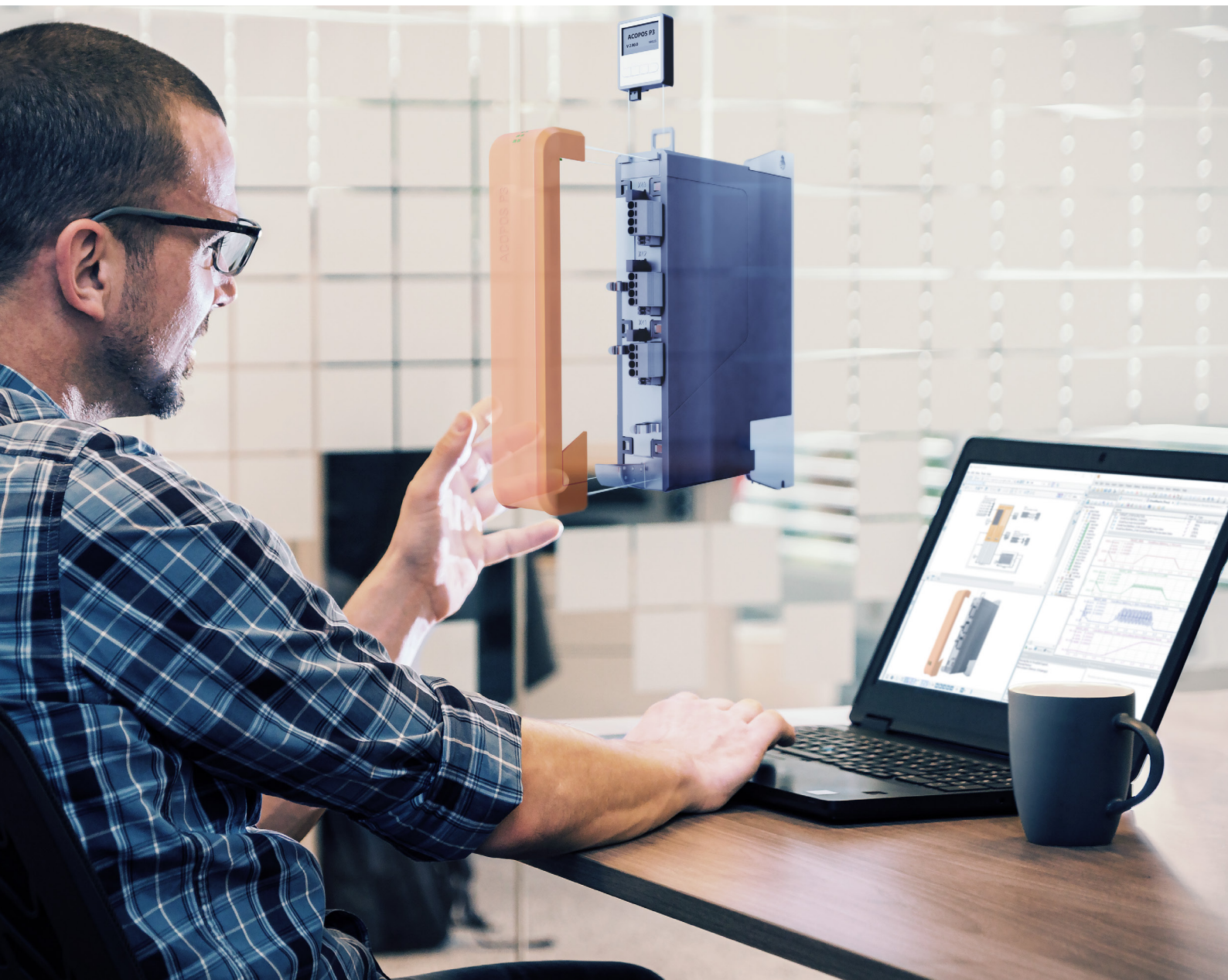

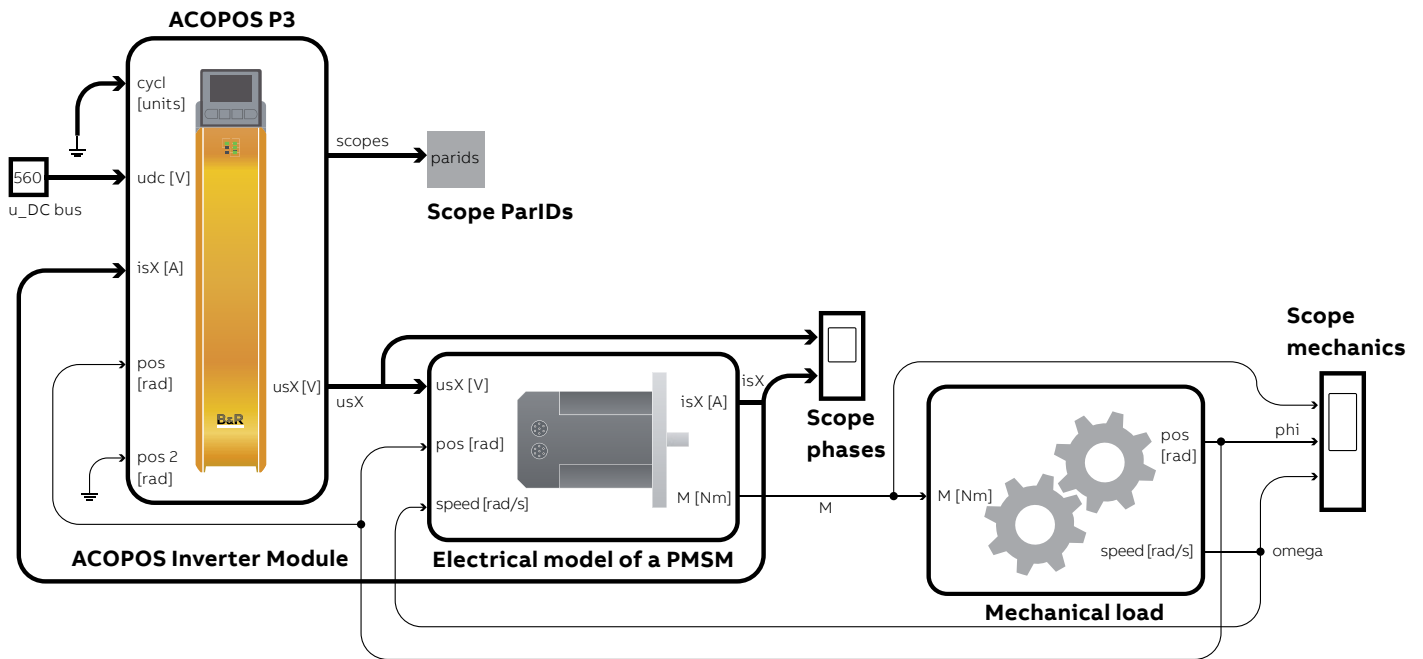

02

01 Simulation replaces costly and time-consuming testing on real hardware.

02 Complete drive solutions can be imported into MATLAB/Simulink at the push of a button.

To simulate the drive solution, the developer creates a dynamic model, for example from the CAD data of the machine model, and imports it into MATLAB/Simulink. Using the ACOPOS for Simulink library, the model can then be linked to different B&R drive variants.

The developer can test the different variants for the model and analyze all values and data directly in MATLAB/Simulink. ACOPOS servo drives as well as a variety of permanent magnet synchronous motors are supported.

Better program code

In the simulation environment, physical variables such as phase voltage, phase currents or load speed as well as internal states of the drive can be viewed in simulated real time, allowing the developer to easily determine the optimal combination of drive components and design a perfect control solution.

Simple processes such as movements and autotuning can also be programmed, which helps prevent development errors and improves the quality of the application code. The time and effort required for commissioning is reduced.

⊕ BENEFITS FOR MACHINE BUILDERS

- Shorter time to market
- Improved code quality
- Optimized drive solutions save costs

⊕ BENEFITS FOR MANUFACTURERS

- Faster commissioning
- Reduced susceptibility to errors
- Lower maintenance costs
- Better control quality

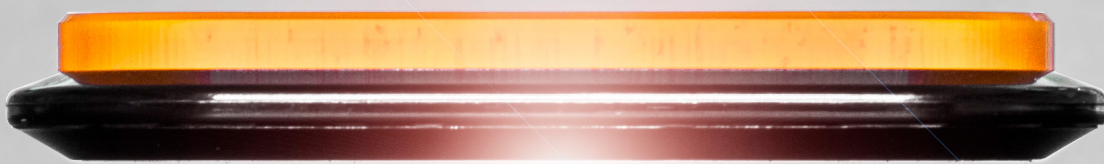

A new dimension of manufacturing

With ACOPOS 6D, B&R heralds a new era of manufacturing. Shuttles carry individual products freely through the machine, powered by magnetic levitation. Gone are the days when conventional transport systems imposed rigidly defined timing on the production process. ACOPOS 6D enables economical small-batch production with frequent changeover between products of different designs and dimensions.

01 ACOPOS 6D enables economical small-batch production with frequent changeover between products of different designs and dimensions.

ACOPOS 6D opens up entirely new possibilities. Machine builders can forget every preconception of what a machine looks like and open up entirely new markets with disruptive machine designs. The footprint of existing machines and lines can be reduced dramatically.

ACOPOS 6D is based on the principle of magnetic levitation: Shuttles with integrated permanent magnets float over the surface of electromagnetic motor segments. The modular motor segments are 240 x 240 millimeters in size and can be arranged freely in any shape. A variety of shuttle sizes carry payloads of 0.6 to 14 kilograms and reach speeds of up to 2 meters per second. They can move freely in two-dimensional space, rotate and tilt along three axes and offer precise control over the height of levitation. All together, that gives them six degrees of motion control freedom.

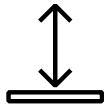
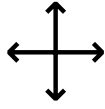

ACOPOS 6D

Rotation (X, Y)
< 20°

Speed profile (X/Y)
2 m/s

Levitation height
0.5 - 4 mm



Compact and adaptive

With intelligence built right into the transport system, complexity is reduced throughout the rest of the machine. Processing stations can be simplified or eliminated entirely, reducing hardware costs and shrinking the footprint while making the machine more adaptive. ACOPOS 6D shuttles can be used as axes in processing stations, introducing intelligence right where it is needed.

A shuttle carrying a workpiece could follow a CNC path, for example, allowing the processing tool to be mounted rigidly. Weighing stations are no longer needed, since each shuttle can also serve as a high-precision scale. ACOPOS 6D also offers up to four times the shuttle density of other systems on the market through the unique ability to control four shuttles on the same motor segment simultaneously.

Zero wear

ACOPOS 6D shuttles levitate freely without any contact or friction. With no abrasive wear, there are no parts to be maintained. The motor segments can be covered with a sheet of stainless steel or other food-safe materials, enabling the ACOPOS 6D to be used in cleanrooms and food and beverage production.

⊕ BENEFITS FOR MACHINE BUILDERS

- Capture new markets
- Easy development
- Simplified processing stations with intelligence built into transport

⊕ BENEFITS FOR MANUFACTURERS

- Profitable small-batch production
- Drastic footprint reduction
- Total adaptability



01



02

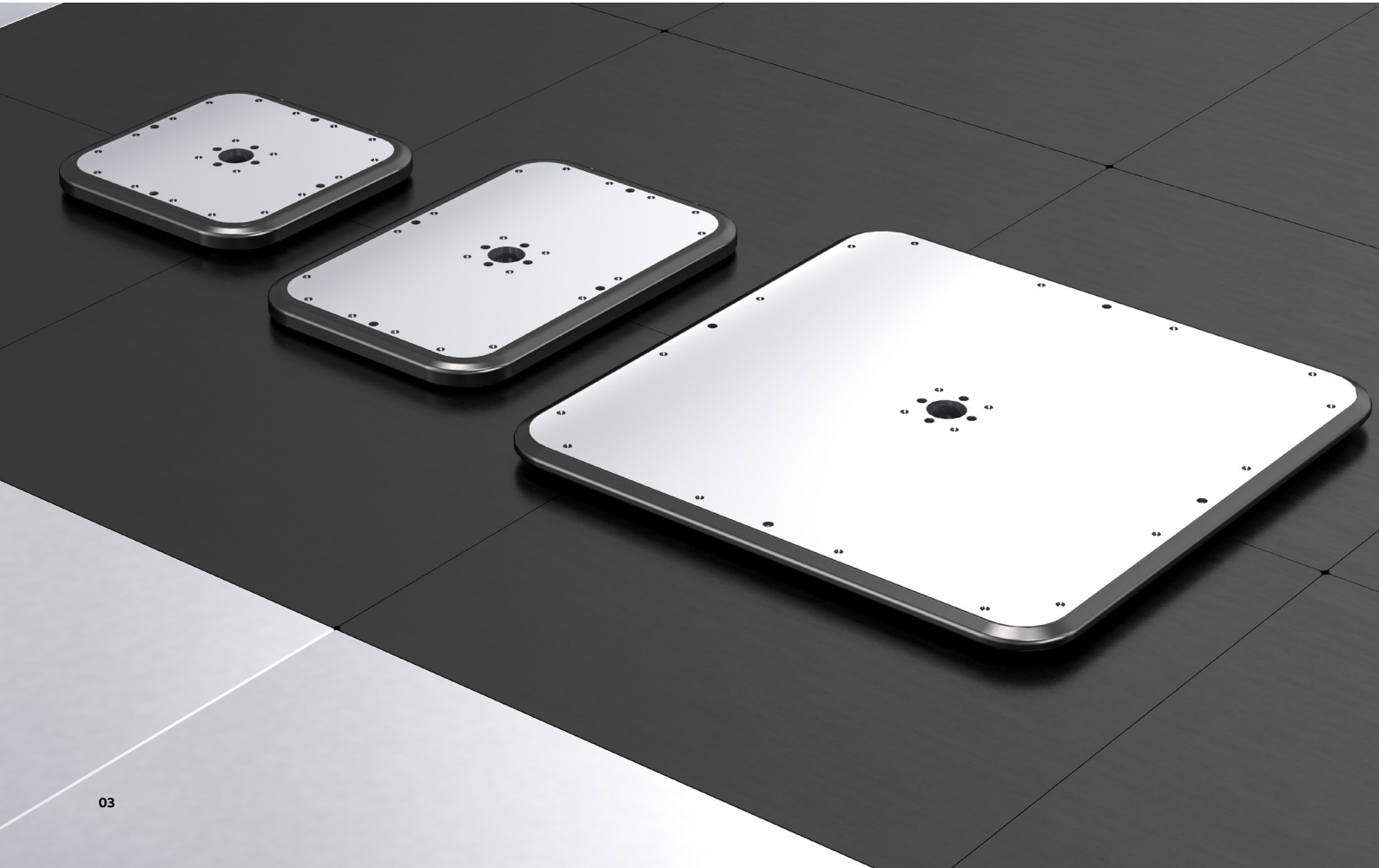

03

01 ACOPOS 6D enables zero-contact transport through the production process.

02 Shuttle movement replaces additional axes at processing stations.

03 Shuttles are available in sizes from 120 x 120 to 450 x 450 mm.

Fully integrated

ACOPOS 6D is fully integrated in the B&R ecosystem. That allows the shuttles to be synchronized with servo axes, robots, track systems and machine vision cameras with microsecond precision. Path planning for the shuttles occurs in a dedicated controller, connected to the machine network via POWERLINK – which means it has no impact on the performance of the network or machine control system. For systems with more than 200 segments or 50 shuttles, multiple controllers can be synchronized with each other.

Easy setup

ACOPOS 6D offers nearly limitless possibilities in machine design, yet is remarkably easy to set up. Sophisticated algorithms ensure the shuttles follow an optimal path while avoiding collisions and minimizing energy consumption. Developers are free to concentrate on their primary task: developing optimal machine processes that deliver maximum productivity.

Micron precision

Unlike comparable systems, each ACOPOS 6D shuttle is assigned a globally unique ID. At startup, the controller immediately knows the location of each shuttle on the motor segments, and production can begin without time-consuming homing sequences or manual input by an operator. The shuttles offer a positioning repeatability of $\pm 5 \mu\text{m}$, making ACOPOS 6D perfectly suited for applications with strict positioning requirements, like those in the electronics industry and in the assembly of mechanical and electronic components.

Technical data	ACOPOS 6D
Speed	2 m/s
Acceleration	20 m/s ²
Positioning repeatability	$\pm 5 \mu\text{m}$
Levitation height	0.5 - 4 mm
Angle of rotation (Z)	< 20°
Angle of tilt (X, Y)	< 20 mrad
Max. load	0.6 - 14.4 kg



01

More productive with delta robots

B&R has integrated Codian D2, D4 and D5 robots into its automation landscape, making it possible to implement high-precision pick-and-place applications in just a short amount of time.

01 Delta robots from Codian are fully integrated into B&R's automation technology.



Adaptive and flexible manufacturing and logistics concepts as well as small quantity orders down to batch size one mean that it's necessary to respond quickly to changing requirements. Including robots in automated processes is the logical conclusion. To make things as easy as possible for machine builders, B&R has integrated several Codian delta robot series into its automation ecosystem. The customer therefore has a single supplier for the control system, development environment and robotics technology. Since one controller can manage both the machine and the robot, it's often possible to do away with a dedicated control cabinet for the robot – which is great for reducing the overall footprint of the system.

Simple and precise

At the same time, predefined function blocks can be used to simplify the programming of the motion sequences. The performance parameters of the robots are provided in accordance with ISO 9283, which makes configuration much easier and eliminates the need for in-house performance testing. In addition, the unit comprising the robot, controller, operator panel and software is

already declared as partly completed machinery in accordance with the Machinery Directive – shortening time to market and securing a competitive advantage.

During operation, end users benefit from the precise synchronization of the mechanical axes and the robot movements. This guarantees short cycle times, which in turn enables faster production as well as shorter logistics processes. With the same user interface for both the robotics and automation components, it's easy to get up to speed with the entire system.

Fast and versatile

Codian robots can sort, assemble or arrange products at conveyor belt speeds up to 60 m/min. The spectrum ranges from very small kinematics with up to 1.5 kg payload and a minimum working range of 500 mm – well-suited for confined installation environments – to larger models capable of handling payloads up to 35 kg or even 125 kg. This opens up pick-and-place operations for heavy products as well. Special hygienic variants are also available for primary packaging in the food and beverage industry.



Technical data	D4
Number of axes	3 / 4
Max. load	3 - 35 kg
Workspace	650 - 2100 mm
Protection	IP54 / IP69K (hygienic)

Technical data	D2
Number of axes	2 / 3
Max. load	3 - 125 kg
Workspace	500 - 1500 mm
Protection	IP54 / IP65



Technical data	D5
Number of axes	5
Max. load	1.5 - 35 kg
Workspace	650 - 1600 mm
Protection	IP54

mapp
MOTION

⊕ BENEFITS FOR MACHINE BUILDERS

- Only one development environment
- Shorter time to market
- No in-house performance testing
- Easier service

⊕ BENEFITS FOR MANUFACTURERS

- Higher quality
- Higher throughput
- One operator interface for robotics and automation
- Smaller footprint

Create robotics applications in minutes

A ready-made software solution from B&R helps OEMs implement pick-and-place applications significantly faster with minimal investment risk. mapp Pick&Place makes machines faster, more flexible and more efficient.

01 With mapp Pick&Place, applications can be set up with just a few clicks.

02 The mapp components exchange all the information they need with each other automatically.

Application engineers do not need any in-depth robotics know-how. All they have to do is select prefabricated functions and link them together. This way, a working robotics application can be created in just a few minutes. The risk of costly development mistakes is minimized, and the return on investment for robotics is maximized.

mapp Pick&Place grants the user maximum freedom to solve the requirements of their process using any number of delta, articulated arm or SCARA robots. The number of conveyor belts for infeed and outfeed can also be configured as

desired. The software also allows developers to automatically optimize their process for a maximum pick rate.

Configuring, not programming

As part of the mapp Technology software framework, mapp Pick&Place is automatically linked to all of the other mapp components. It takes only a few clicks to set up coordination with other motion axes, track systems, B&R machine vision components or web-based mapp View HMI applications. Much of the development time otherwise spent on manual programming has been eliminated.



01

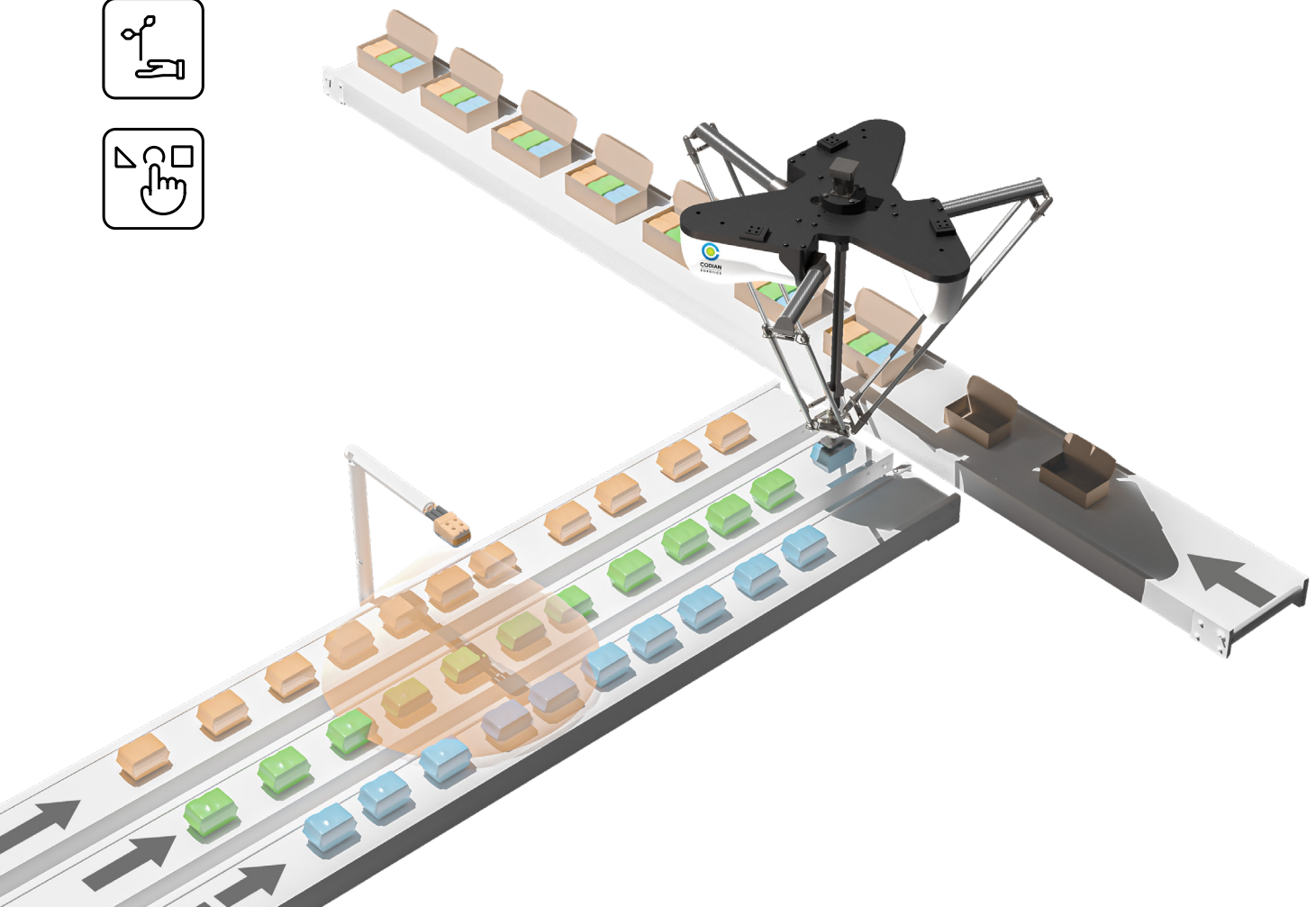

Higher throughput

Pick-and-place applications are highly reliable – the scrap rate when using robots decreases considerably in comparison with conventional processes. mapp Pick&Place is designed to enable product changes without time-consuming reprogramming. Lengthy changeover times are eliminated.

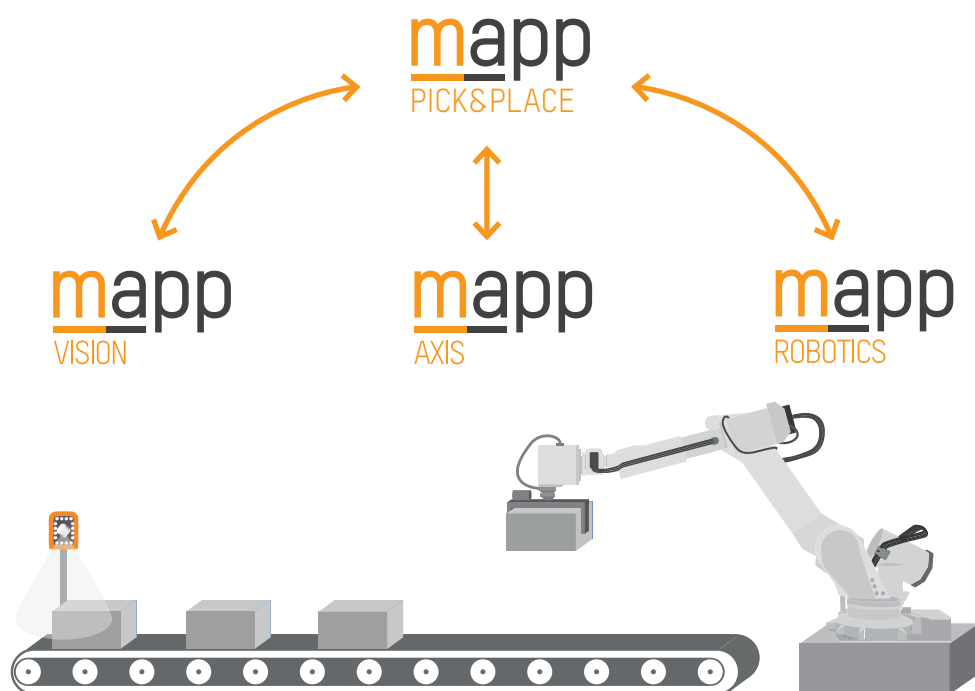

02

mapp
MOTION

⊕ **BENEFITS FOR
MACHINE BUILDERS**

- Low investment risk
- Minimal programming effort
- No specialist knowledge required

⊕ **BENEFITS FOR
MANUFACTURERS**

- More efficiency
- Reduced waste
- Rapid changeover

New shuttles for ACOPOStrak

Modular transport systems like B&R's ACOPOStrak play a key role in enabling adaptive manufacturing systems that bring the economy of mass production down to batch size one. The next step in the evolution of this revolutionary technology is a new shuttle that runs even smoother and delivers even higher positioning accuracy while at the same time experiencing less wear for an extended service life.

01 The smooth-running new shuttle design offers reduced wear and higher positioning accuracy.



The shuttles of the ACOPOStrak system have a brand new core with significant upgrades, including a heightened positioning accuracy of $\pm 200 \mu\text{m}$. At the same time, the form factor hasn't changed a bit – the new shuttles can be operated right alongside their predecessors without limitations. The differences are on the inside. The shuttles have been optimized for smooth operation, which in turn reduces wear and improves accuracy. Like their predecessors, the new shuttles come in widths of 50 and 100 mm and are optionally available with diverter capability.

New possibilities

Higher accuracy means that the track system can now unlock considerable time and expense savings in a variety of new applications – such as the assembly of medical devices like catheters or insulin pumps. Both cases involve relatively lightweight components whose assembly requires a very high degree of precision. Similar applications exist in the assembly of battery cells.



About ACOPOStrak

Material transport is a core element of automated manufacturing. To meet the demands of flexible and adaptive manufacturing, however, today's track systems must do much more than just move things from A to B. With high-speed diverters and infinite layout possibilities, ACOPOStrak offers ultimate design freedom. Its independent shuttles add value throughout the production process – grouping, sorting and buffering on the fly and even serving as an additional motion control axis.



High precision

Long service life

Smooth operation

01

mapp
TRAK

**⊕ BENEFITS FOR
MACHINE BUILDERS**

- Improved accuracy
- New application possibilities
- Open up new markets

**⊕ BENEFITS FOR
MANUFACTURERS**

- Lower maintenance costs
- Improved accuracy
- Fully compatible with predecessor

Batch size 1 in washdown environments

B&R now offers a washdown variant of ACOPOStrak, the modular, intelligent track system for advanced manufacturing. With strong IP69K protection against dust and water ingress, components can be cleaned by high pressure or at temperatures up to 80°C, making it possible to use this system in hygienically demanding industries. Not only that, but this track system now makes economic sense in these areas when producing small batch sizes.

01 The washdown variant of the flexible ACOPOStrak transport solution can be used in hygienically demanding applications.



TCO



TTM



Industries such as food or pharmaceuticals place very high demands on the cleanliness of all plant components involved in production. Now these industries are facing a new trend: personalized products – and with them the demand to be able to produce small batches efficiently. Intelligent transport systems play an invaluable role here. B&R now offers a washdown variant of the ACOPOStrak, which allows the advantages of this track system to also be used in these areas of application.

Dirt and water stay outside

With this new ACOPOStrak variant, guides, segments (i.e. motors and servo drives) and cables/connectors that are part of the track system can now be washed down – with high-pressure cleaners, steam up to 80°C or

even cleaning agents such as chlorine foams or hydrogen peroxide.

All components are constructed of stainless steel (1.4404), whose high resistance to corrosion makes it the ideal choice for use in the pharmaceutical and food industries.

All contact surfaces are laser-welded to prevent the ingress of dirt, and each component complies with IP69K protection requirements. The track system also demonstrates its reliability when operated in harsh environmental conditions, positively impacting overall plant availability. The proven ACOPOStrak system can now also be used in applications involving filling systems and primary packaging as well as in the pharmaceutical industry.

⊕ BENEFITS FOR MACHINE BUILDERS

- Access new markets
- Use even under harsh environmental conditions

⊕ BENEFITS FOR MANUFACTURERS

- Simplified daily maintenance
- Higher availability
- Economical small-batch production



01

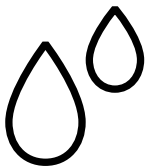

H2O2

Corrosion resistant



IP69K

Impervious to dust and dirt

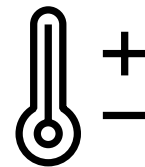

80°C

Washdown ready

Usability accelerates development with ACOPOStrak

B&R has expanded its system software for the ACOPOStrak transport system with two new features that make work much more efficient: A diagnostics function that makes it easier to troubleshoot errors and a Convoy feature for programming a group of shuttles as a unit. This makes development faster and easier while also reducing the risk of errors and increasing overall equipment effectiveness (OEE).

01 The Convoy feature allows groups of track system shuttles to be treated as units. All the necessary calculations are handled in the background to prevent traffic jams, collisions or separation of units.

02 Find errors without having to search line-by-line of code – the ACOPOStrak transport system software makes it possible.

The new Convoy feature makes programming ACOPOStrak even easier than ever. The track system's shuttles can be grouped together and handled as a single unit. This helps to prevent problems like traffic jams, collisions or the separation of transport units. Programmers no longer have to worry about any of these things. All the necessary calculations are handled by the software in the background. This saves valuable time in development and helps get new products to market faster. Reduced risk of error means higher quality code.

Diagnostics with just a few clicks

In addition, machine builders can now provide their customers with important diagnostics information with just a few clicks via the mapp AlarmX software component. The new addition to the ACOPOStrak track system software makes it easy to identify the type of problem and the exact location down to the affected component – without requiring any knowledge in Automation Studio. Machine operators no longer have to rely on the OEM for troubleshooting and can more quickly identify where corrective measures are required. This increases user-friendliness and reduces downtime.



mapp
TRAK

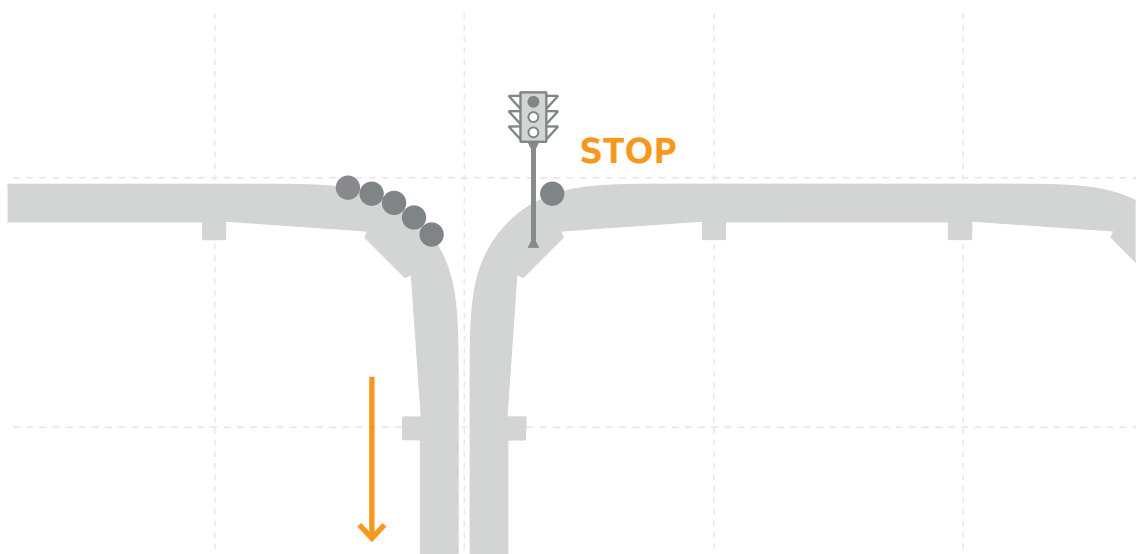



02



⊕ BENEFITS FOR MACHINE BUILDERS

- Faster troubleshooting
- Higher-quality, leaner code
- Reduced development time
- Offer new services

⊕ BENEFITS FOR MANUFACTURERS

- Troubleshooting independently of OEM
- Higher OEE
- Shorter time to market

Implementation of vision applications made easy

A new graphical editor in B&R Automation Studio makes implementing complex machine vision applications easier and more intuitive than ever. Traditional programming work is no longer necessary.



Vision functions are simply selected and connected in a graphical interface. Since vision is an integral part of B&R's automation landscape, variables from the machine application are readily available without having to use an additional

interface or adapt data formats. In no other system can a smart camera be so easily integrated into a control application. High performance and exact synchronization help improve quality and increase throughput.



⊕ BENEFITS FOR MACHINE BUILDERS

- Lower development costs
- Shorter time to market
- Less susceptible to errors
- Lower investment risk

⊕ BENEFITS FOR MANUFACTURERS

- More reliable machines
- Easier updates
- Improved OEE

01 The new graphical user interface makes it much easier to create applications.

mapp
VISION



Lower investment risk

Deep integration reduces the susceptibility to errors and thus massively decreases investment risk. The B&R system automatically takes care of communication between all components of the automation system. A logic check is performed in the background during configuration in the graphical editor. If a setting causes problems, the application engineer is immediately notified of where the problem occurred. Tediously searching

for errors in thousands of lines of code is now a thing of the past. Applications can be created, tested and modified offline, directly on the machine or even without actual hardware. This makes applications much more stable and less prone to errors. The Online HMI function allows parameters and algorithms to be changed at any time via the machine's user interface, even after commissioning.

Less waste with better images

B&R has optimized its vision functions Blob and Matching. More precise, reliable vision applications make machines more productive.



The Blob function can now be used on a Smart Camera with subpixel accuracy. A sophisticated algorithm evaluates the raw image data and calculates much more accurately where the edges are located. The Blob function can be used in registration mark detection, for example, where it can significantly improve print quality. The much lower measurement tolerances also mean that vision applications become more reliable.

Reduced waste

The Matching function can now reliably detect deformed objects on products, such as on bags of potato chips. The material waste resulting from rejecting unrecognized objects is reduced, leading to a direct increase in quality with a positive impact on overall productivity. Both of these improved vision functions are available as function blocks via a simple software update. Application engineers do not need any specialist knowledge of machine vision systems to use them.

⊕ BENEFITS FOR MACHINE BUILDERS

- Higher measurement accuracy
- More reliable results
- Easy development without specialist knowledge

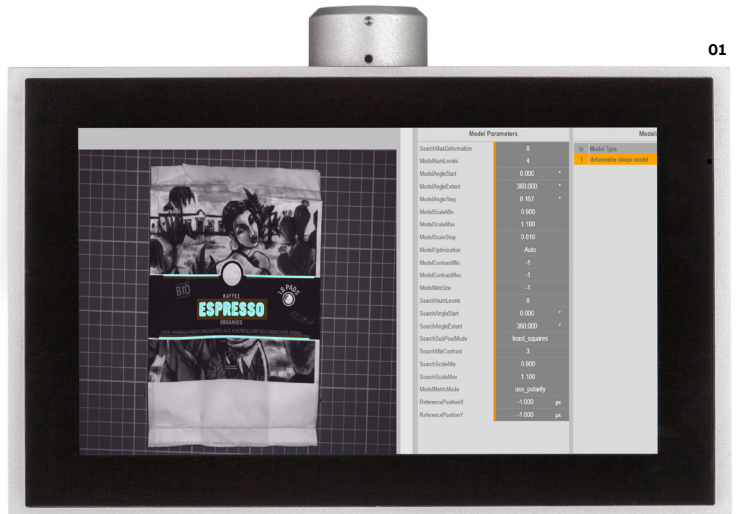

01

01 The Matching function now also detects shapes on irregular surfaces.

⊕ BENEFITS FOR MANUFACTURERS

- Improved quality
- Higher throughput
- Reduced waste



Perfectly synchronized with just a few clicks

B&R machine vision systems can now be connected with an axis in just a few clicks. This makes it possible to synchronize image acquisition to a specific axis position with microsecond precision. Classical programming work is not necessary. Development expenses are reduced and the code quality is increased.



mapp
VISION

mapp
MOTION

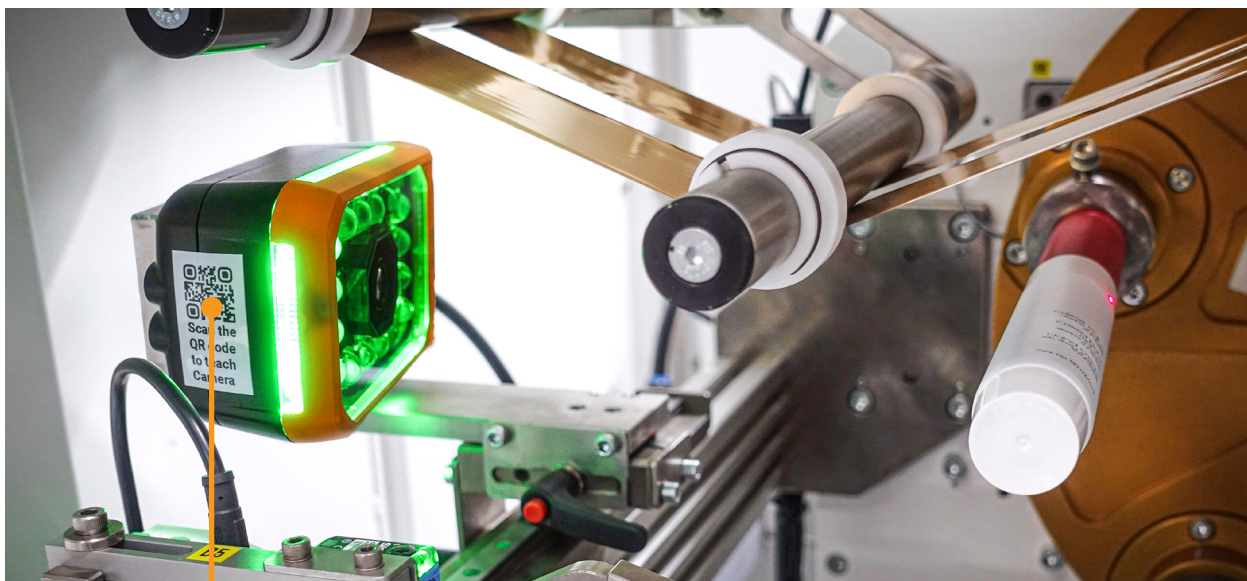

All it takes to synchronize the movement with the image acquisition is linking the desired function blocks. The investment risk involved in using machine vision is reduced and the quality of the application is increased substantially. Downtime is avoided altogether, resulting in a much more productive machine.

⊕ BENEFITS FOR MACHINE BUILDERS

- Reduced development time
- More reliable code
- Lower investment risk
- Enhanced machine features

⊕ BENEFITS FOR MANUFACTURERS

- Reduced waste
- Increased productivity

Security at the core of automation with APROL

B&R has fundamentally revised the technological basis of its APROL distributed control system. The requirements of increasing flexibility and networking in production can thus be met with great ease, reliably and with enhanced performance.



01 APROL release 4.4 meets the security requirements of networked production facilities that are constantly exposed to risks from the Internet.

APROL release 4.4 is based on the new SUSE Linux Enterprise Server 15 SP4. This operating system is specially hardened for critical applications and meets the security requirements of networked production facilities that are constantly exposed to risks from the Internet.

Better performance and added security

A new update policy based on containerization technology enables APROL R4.4 to protect applications better than ever. Software modules are encapsulated in independent packages, called containers, which can each be updated selectively without affecting the others. When the APROL version itself is updated, the entire system is upgraded automatically without requiring any manual intervention in the project.

The new release also offers a significant increase in performance and numerous new functions, as well as updating key APROL components to the latest versions, including Linux kernel 5.14, OpenSSL 3.0, MariaDB 10.6, PHP 8 and PostgreSQL 14. This is an important foundation for ensuring IT security.

Database with improved performance

APROL will rely on TimescaleDB as its database for historical data from now on. This introduces more performance and security to APROL. TimescaleDB combines the ease of use of a relational database

with the speed of a NoSQL database. The short access times provide an ideal foundation for evaluation using the JasperReports server.

This report server has also been upgraded to the latest version 8.0 and now runs in a container. Reports with clear layouts can now be created even more easily and with more functions. B&R has also significantly increased the performance of report generation and analysis.

Simple IT integration

As more and more automation solutions are integrated into a company's IT structure, B&R has expanded the management of its user/role systems. With an advanced 389 - Directory Server, authentication can now be performed either locally using the APROL server or by using an external LDAP server, significantly simplifying user management while making it more secure.

About APROL

APROL is B&R's highly scalable distributed control solution. It supports system integrators and operators through a system's entire lifecycle – from planning, library creation and configuration to commissioning and operation. Seamless integration and intuitive operation reduce setup times and ensure the highest level of machine and system productivity while providing flexibility for product changeovers.

⊕ BENEFITS FOR PROJECT ENGINEERS

- Flexible, open platform
- Easily meets modern IT requirements
- Built-in security
- Easy migration

⊕ BENEFITS FOR PLANT OPERATORS

- Easy integration into IT structures
- Clearer operation
- Improved performance during analysis

Maximum security in just a few clicks with certificates

B&R has extensively expanded APROL's certificate handling. APROL installations and associated B&R hardware now support additional certificate types. It is therefore easy to implement a production-wide, uniform certificate system.

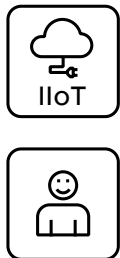

B&R components are now able to request certificates from external servers (certificate authorities) and thus automatically secure the communication. APROL additionally supports the following certificate types: PEM, DER, PKSC7/P7B and PKSC12/PFX. Plant operators can use their preferred or existing certificate handling system. APROL fits in seamlessly and without additional effort.

Increased speed with elliptical curves
APROL release 4.4 also supports certificates with elliptical curves (ECC). These certificates can be processed much faster with the same level of security. This speeds up communication establishment within a production network. The encryption mechanisms are implemented in such a way that they can be used by an automation technician without special IT knowledge.

Automatic validity checks
Expired certificates can sometimes shut down entire machines and manufacturing systems. For this reason, B&R has greatly expanded the frequency of inspections for dates that will expire. All expiration dates are pre-checked when applications are created and built, as well as before each certificate download.

There are also regular validity checks, for example, to detect incorrect system times that could cause certificates to be considered expired. It is also possible to create a status variable for certificate information such as the expiration date so expiring certificates can be detected in the application well in advance.

01 Plant operators can use their preferred or existing certificate handling system. APROL fits in seamlessly and without additional effort.

02 A production-wide, uniform certificate system is easy to implement with APROL.

01

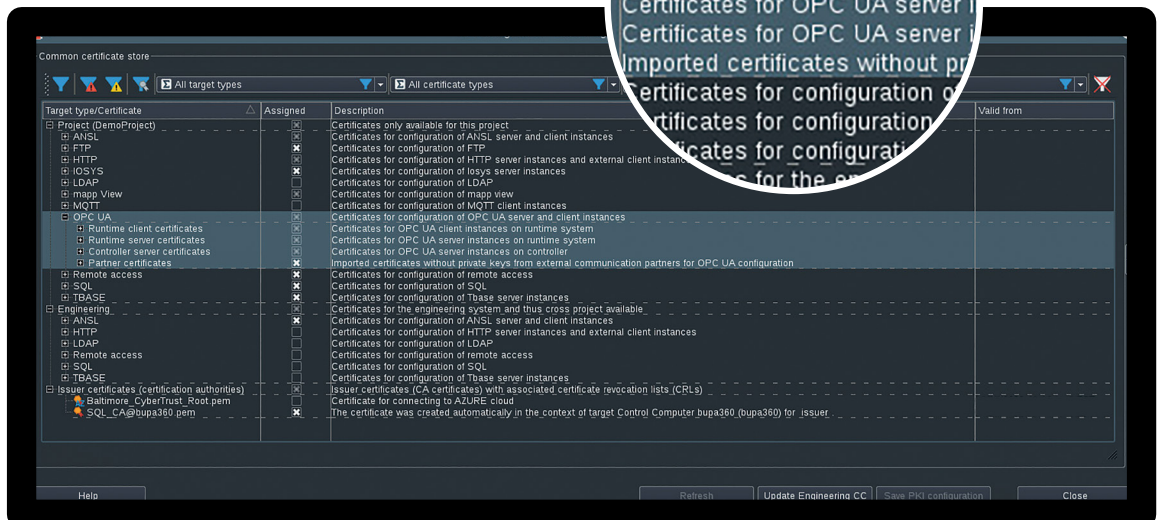

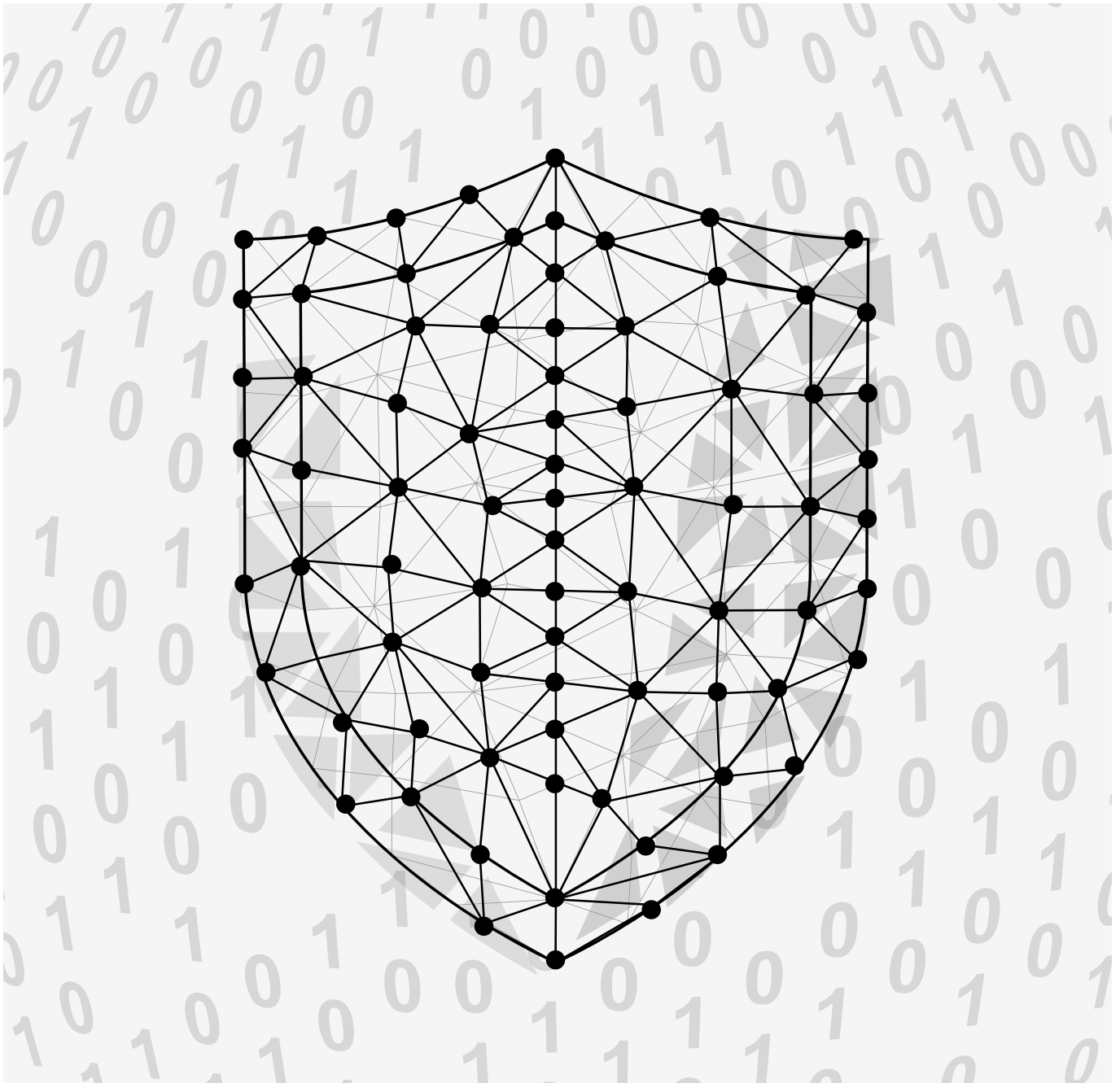

02

⊕ **BENEFITS FOR
PROJECT ENGINEERS**

- No special IT knowledge required
- Certificates for B&R and 3rd-party devices

⊕ **BENEFITS FOR
PLANT OPERATORS**

- Easy integration into IT environments
- Faster communication
- Higher security

Much easier lifecycle management

The more complex and networked that automation projects turn out to be, the greater the amount of effort required for lifecycle management. With intelligent patch management and additional functions, B&R massively reduces this effort in APROL projects.



01

01 Automated operating system updates save many hours of work and enable higher system availability.



B&R regularly provides patches for APROL and its system components in order to ensure the security of the system. Patching all hardware manually for large installations can, however, be a major effort.

Patch installations with the new AprolPatchInstaller can now be scheduled and executed over the network. The application has its own user interface but can also be integrated directly into tools such as "Red Hat® Ansible® Automation" for automating IT tasks.

Tamper-resistant RPMs

Patch installations are also now even more secure – all patches are signed with RPM files, guaranteeing that only patches certified by B&R can be applied. Potential hacker attacks or other types of manipulation are thus averted. This applies not only to the APROL system itself but also to Automation Studio and Automation Runtime.

Increased availability

B&R has also automated operating system updates for controllers so they no longer need to be updated individually. The "Change AR OS" function updates the desired controllers and also offers the option of automatic versioning, compilation and build. This can save many hours of work, and faster updates mean higher system availability.



⊕ BENEFITS FOR PROJECT ENGINEERS

- Guided lifecycle management
- Competitive service capabilities

⊕ BENEFITS FOR PLANT OPERATORS

- Increased availability
- Higher security
- Lower costs for lifecycle management

The right hardware for every situation

B&R is expanding APROL's application possibilities with new hardware. With a new controller family, a powerful industrial PC with IP69K protection and a bus controller for OPC UA FX, it is easy to implement advanced solutions such as decentralized automation and powerful edge controllers.



01 Extended application possibilities: Decentralized automation solutions or powerful Edge Controllers are now even easier to implement.

The Automation PC 3100 mobile is a powerful and extensively equipped industrial PC with a Core i7 processor. This device is designed for harsh environmental conditions and able to withstand extreme temperatures, vibration and shock. For example, the PC can be used as an Edge Controller directly in the manufacturing system to collect and aggregate large amounts of data.

Decentralized controllers

The new X20EM embedded controller family is particularly compact yet very efficient. It allows

the realization of decentralized automation concepts very easily and cost-effectively.

Multiple access with OPC UA FX

APROL is now prepared for communication using OPC UA. With the X20BC008T bus controller, remote I/Os can be connected directly with a runtime server or controller using an OPC UA client. An existing Ethernet infrastructure can be used for this purpose, eliminating the extra effort and complexity involving additional wiring. The bus controller is also already prepared for communication with OPC UA FX.

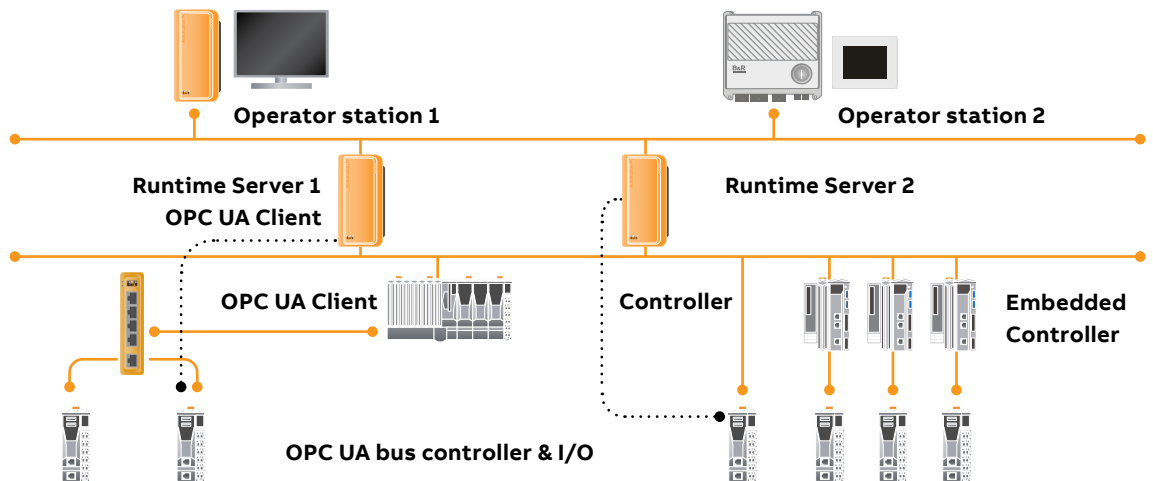

01

⊕ BENEFITS FOR PROJECT ENGINEERS

- Scalable hardware portfolio
- Easy implementation of decentralized architectures

⊕ BENEFITS FOR PLANT OPERATORS

- Less costs for wiring
- High computing power directly in the manufacturing system

Big possibilities, little effort – with OPC UA

B&R continues to expand OPC UA support in APROL. This is making it easier to convert raw data into conclusive information that can be transferred to a cloud or plant information (PI) system for big data analysis.



01 Methods are defined with easy-to-use configuration blocks. An automation engineer does not need any OPC UA know-how and can use the programming methods they are familiar with.

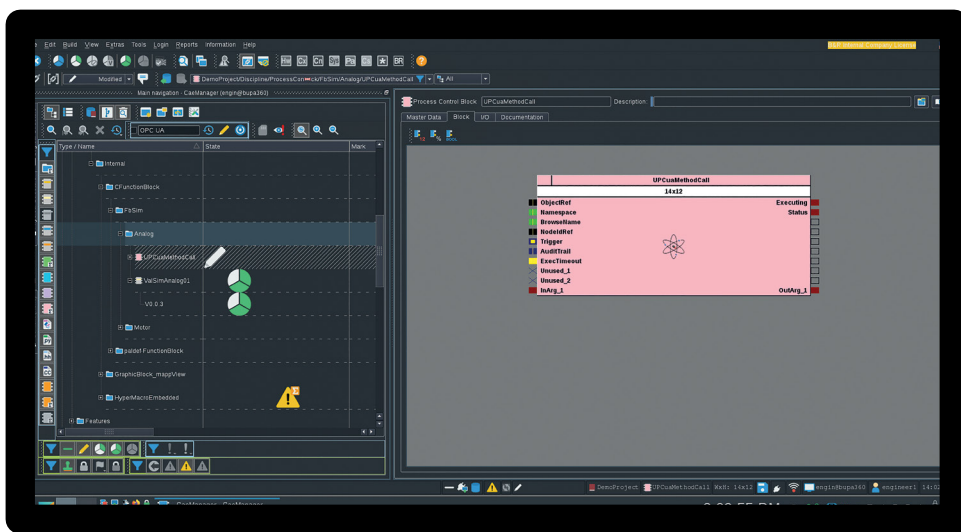

01

To make this possible, B&R has extended the address space modeling of the OPC UA server so that properties of process variables can now be specified. Configuration blocks are used for this purpose.

Methods for simplified access

In addition, method calls on APROL controllers or in the runtime system are now possible via OPC UA. A method is defined in an easy-to-use configuration block, while the function in the

background can be programmed either in CFC, ST or SFC.

An OPC UA client in APROL can therefore execute all available methods on an OPC UA server without requiring knowledge of the underlying functions and procedures. Moreover, automation engineers do not need any special OPC UA know-how; they can use the programming methods they are familiar with.

⊕ BENEFITS FOR PROJECT ENGINEERS

- No specialist knowledge required
- Flexible execution of functions
- Security already integrated

⊕ BENEFITS FOR PLANT OPERATORS

- Simple cloud connection
- Simple big data analytics
- Simpler interfaces



B&R
Industrial Automation GmbH
A member of the ABB Group
B&R Straße 1
5142 Eggelsberg, Austria
office@br-automation.com

t +43 7748 6586-0
f +43 7748 6586-26

br-automation.com